

# 2014

## **SCRI-MINDS – YEAR 5 FINAL REPORT**

**PRECISION IRRIGATION AND NUTRIENT MANAGEMENT FOR  
NURSERY, GREENHOUSE AND GREEN ROOF SYSTEMS:**

**WIRELESS SENSOR NETWORKS FOR FEEDBACK AND FEED-FORWARD CONTROL**

**JOHN LEA-COX  
ANDREW RISTVEY  
BRUK BELAYNEH  
WILLIAM BAUERLE  
MARC VAN IERSEL  
MATTHEW CHAPPELL  
PAUL THOMAS  
GEORGE KANTOR  
DAVID KOHANBASH  
TARYN BAUERLE  
ERIK LICHTENBERG  
JOHN MAJSZTRIK  
DENNIS KING  
RICHARD BAUER  
COLIN CAMPBELL  
LAUREN CRAWFORD  
TODD MARTIN**

**25<sup>TH</sup> NOVEMBER, 2014**

## TABLE OF CONTENTS

<b>TABLE OF CONTENTS</b> .....	2
<b>THE ISSUES</b> .....	4
<b>WHAT THE SCRI-MINDS PROJECT HAS DEVELOPED</b> .....	4
<b>DEMONSTRATED BENEFITS OF WIRELESS SENSOR NETWORK CONTROL SYSTEMS</b> .....	4
<b>A. ENGINEERING – HARDWARE AND SOFTWARE DEVELOPMENT</b> .....	7
1. <b>Decagon Devices, Inc.</b> .....	7
1.1 Hardware Development.....	10
1.2 Decagon Software Development.....	10
1.3 PlantPoint System Commercial Release.....	12
1.4 PlantPoint System Installation, Training and Support.....	12
2. <b>Carnegie Mellon University</b> .....	14
2.1 Sensorweb Software Development.....	14
2.2 Sensorweb Supported Networks.....	16
<b>B. SCIENTIFIC RESEARCH AND DEVELOPMENT</b> ).....	17
1. <b>Colorado State University</b> .....	17
1.1 Implications of Minimum Stomatal Conductance on Estimating Water Flux in Nurseries.....	17
1.2 Seasonal Canopy Aerodynamics: Potential Implications for Transpiration Estimates.....	19
1.3 Species-specific Irrigation Scheduling: A Comparison to Substrate Moisture Sensing.....	19
1.4 Genera Conclusions from Year 5.....	21
2. <b>Cornell University</b> .....	22
2.1 Root System Rhizosphere Characterization.....	22
2.2 Further Work on CT imaging to Measure Root Traits Belowground.....	24
3. <b>University of Georgia</b> .....	27
3.1 New Technology Development.....	27
3.2 Measuring Electrical Conductivity.....	27
3.3 Sensorweb Supported Networks.....	28
3.4 Production Research: Plant Quality.....	28
3.5 Production Research: Irrigation and Fertilization.....	29
3.6 On-Farm Work.....	31
3.7 Opportunities for Training and Professional Development.....	31
3.8 Dissemination of Results to Communities of Interest.....	32
4. <b>University of Maryland</b> .....	33
4.1 Bauers Greenhouse: Cut-flower Snapdragon Production.....	33
4.2 Moon Nursery: Container-Nursery Pathogen Management.....	36
4.3 Hale and Hines Nursery: Pot-in-Pot Production.....	39
4.4 Raemelton Farm: Field Tree Production.....	42
4.5 Waverly Nursery: Field Shrub and Tree Production.....	44
4.6 Scaling up Green Roof Research.....	45
4.7 Estimating Crop Water Use in the Dulcepamba Watershed in Ecuador.....	49
4.7 People Involved at the University of Maryland.....	53
4.8 Dissemination of Results to Communities of Interest.....	53

<b>C. ECONOMIC AND ENVIRONMENTAL BENEFITS (University of Maryland; UM-Center for Env. Studies)</b>	54
1. Profitability Analysis of Wireless Sensor Networks	54
1.1 Gardenia Production	54
1.2 Pot-in-Pot Tree Production	54
1.3 Gardenia Production in Georgia	54
2. Adoption Prospects of Wireless Sensor Networks	54
2.1 Grower perceptions of wireless sensor technology	54
2.1 Grower willingness to pay for wireless sensor technology	55
3. Calculating Public Benefits	55
4. Engaging Growers and the Industry on Benefits and Limitations of Sensor Networks	55
<b>D. OUTREACH - WEBSITE AND KNOWLEDGE CENTER DEVELOPMENT</b>	56
1. Website	56
2. Knowledge Center Development	56
<b>E. PROJECT FISCAL MANAGEMENT, FINAL MEETING</b>	58
<b>F. TRAINING AND PROFESSIONAL DEVELOPMENT OPPORTUNITIES</b>	59
<b>G. PUBLICATIONS, PRESENTATIONS AND OUTREACH</b>	60
1. Book Chapters	60
2. Peer-Reviewed Journal Articles	60
3. Refereed Conference Proceedings	61
4. Non-Refereed Conference Proceedings	61
5. Trade Articles, Reports	62
6. Invited Presentations	62
7. Abstracts; Conference Presentations	62
8. On-line Learning Modules	63
9. Webinars	65
10. Other Presentations	66
11. Theses and Dissertations	66
<b>APPENDIX A: FINAL FEDERAL FINANCIAL REPORT</b>	68
<b>APPENDIX B: PROJECT RESEARCH AND DEVELOPMENT OBJECTIVES</b>	69

## The Issues:

Optimum management of global water resources presents one of the most critical challenges of the 21st century. Drought, population growth, increased urbanization, ground water overdraft and over-allocation of available surface water all contribute to fresh water shortages here in the United States.

- Agriculture is the greatest consumptive user of water in the US, and in many regions agricultural water use cannot be sustained. Irrigation accounts for 62% of freshwater (surface and ground water) use in the United States (Kenny et al., 2009).
- More than 55.4 million acres of land were irrigated in the United States in 2013, of which 72% were irrigated by sprinkler and micro-irrigation systems ([USDA-NASS, 2014](#))
- The issues of water scarcity and water security were highlighted in recommendations by the Water Working group of the nation's Land-Grant Institutions to the US Department of Agriculture in August 2014, entitled "[National Initiative on the Improvement of US Water Security.](#)"

## What the SCRI-MINDS Project has Developed:

- Better tools are needed to assist farmers to use irrigation water as efficiently as possible. With funding from the USDA Specialty Crops Research Initiative (SCRI) the SCRI-MINDS project has developed advanced wireless sensor control technology and software to apply irrigation water based on daily plant requirements.
- This wireless sensor control (WSC) system is now commercially-available as the PlantPoint™ system through one of the SCRI-MINDS project partners (Decagon Devices Inc., Pullman, WA).
- Additionally, the SCRI-MINDS project developed advanced monitoring and control software that extends the capability of the PlantPoint™ systems. This software is commercially available from Mayim, LLC (Pittsburgh, PA).
- The SCRI-MINDS project has supported and benefited from the research of 4 international visiting scientists, 4 post-doctoral research associates, 11 PhD, 4 MS graduate students and 9 undergraduate research interns. Many of the post-doctoral and PhD students are now in academic or research positions at Universities and companies in the US and Korea.

## Demonstrated Benefits of Wireless Sensor Network Control Systems:

*The SCRI-MINDS project has demonstrated that wireless sensor network control systems can provide specialty crop producers with the following benefits:*

- A. Provide Farmers with their Own Real-time Information:** Sensor networks provide farmers soil moisture and environmental conditions for their own farm, via smartphone or any device that can access the internet. This provides farmers with information they trust and act upon. We have learned that most farmers make much better irrigation management decisions because they have access to their own information (Lea-Cox et al, 2013).
- B. Precision Control of Irrigation Water Applications:** We have shown through our research that we can achieve between a 40 and 70% reduction in irrigation water applications with sensor-based set-point irrigation control. For one of our growers, an average 50% reduction in irrigation saved over 43 million gallons of water, and \$6,500 in pumping costs in 2012. In the central valley of California, where water costs are typically \$750 / acre foot, the net cost of this 43M gallons of water would

have been at least \$100,000, without accounting for additional pumping, plant growth or other economic benefits. In this case, the return on investment for the entire sensor network (\$48,000) would have been less than 4 months (Belayneh et al, 2013).

- C. **Advances in Model-Based (Predictive) Irrigation Control:** We have demonstrated that model-based irrigation control (MAESTRA, Bauerle et al., 2014) can be as reliable as sensor set-point control. Predictive model-based irrigation offers a scalable, economic alternative to sensing substrate moisture. To simplify model-based irrigation applications on farms, physiological studies have shown that only two measured physiological parameters ( $g_0$  and  $g_1$ ) can maintain >90% transpiration prediction accuracy among genotypes or species (irrigation functional groups). Moreover,  $g_0$  (as a single measured parameter) is the most influential parameter for predicting species-specific transpiration, is very easy to measure, and measured values provide more accurate model estimates of transpiration than linear extrapolation of the photosynthesis-stomatal conductance relationship.
- D. **Impact on Water Availability:** For most producers, the cost of water is very low compared to other variable costs, such as labor. However, most producers are limited by the capacity of their well, or by the time it takes to irrigate. Water availability and irrigation time is often the major constraint on the amount of land under production. One ornamental grower installed an additional 30-acre production block in 2013 based on the amount of water he saved using sensor-based irrigation.
- E. **Increased Crop Yields and Quality:** The growers now have a tool to further refine their growing practices for increases in yield and quality. For example, Majsztrik et al., (2013) and Lichtenberg et al., (Irrigation Science, in review) demonstrated that more timely irrigation decisions through the use of sensor networks in greenhouse production increased the yield and quality of snapdragon (cut-flowers) by 30% depending on season and cultivar.
- F. **Labor Costs, Risk Reduction:** The automation and control of irrigation control in many nurseries can have a large impact not only on water, nutrient use and disease management, but for many larger nurseries, it is likely to reduce the fixed costs of at least 1-2 full-time irrigation managers. For many ornamental growers, this would amount to between \$50,000 and \$75,000 per year. It is unlikely that these jobs would be lost, since lower-skill jobs (opening and closing valves) would be replaced by higher-skill jobs (monitoring and maintenance, data interpretation) of computer-controlled irrigation systems. With better information provided by sensor networks, irrigation managers are likely to make much better and more timely irrigation decisions, and translate that knowledge into better nutrient management results (e.g. by reduced leaching events)
- G. **Reductions in Nutrient Leaching:** Water moves fertilizer through the soil, so *irrigation management is a key part of nutrient management*. Excessive irrigation leaches fertilizer from the root zone and results in additional fertilizer use. Bayer et al., (2014) found that sensor-based irrigation techniques can greatly reduce the fertilizer leaching, cutting the required fertilizer applications by 50%. We have estimated that just in GA (where the study was conducted), this would save ornamental growers about \$10,000,000 per year in fertilizer costs. For farmers in Maryland and Florida, demonstrating reductions in nutrient use is a key part of complying with State-mandated nutrient management regulations. Reduction in leaching also reduces the runoff from herbicide, fungicide and systemic pesticide applications.
- H. **Reduction in Plant Growth Regulator Chemicals:** Plant growth retardants (PGR's) are widely used in ornamental horticulture to control plant size. Research with poinsettias (Alem et al., 2014) has shown that the use of a controlled water deficit is an effective, non-chemical alternative to the use of PGR's. Reducing the substrate water content reduces the stem elongation rate when plants get

too tall. Using sensor-controlled irrigation systems, growers can maintain a lower substrate water content for as long as needed to get the amount of growth regulation needed. Additionally, the effect of water deficit quickly ends after substrate water content is increased again, in contrast to using PGR's. This makes the effect of water-deficits more predictable than using PGR's, which can have long-lasting and unpredictable effects on elongation rates. The use of non-chemical growth regulation can also be used for marketing purposes, since consumer concern over the use of agrochemicals is steadily increasing.

- I. **Disease Management:** Chappell et al., (2013) showed that with sensor-based irrigation, disease-related losses with Gardenia were reduced from 30% to virtually zero, and the production cycle was shortened from 14 to 8 months, with consequent reductions in inputs (labor, fertilizer, fungicides etc.). Combined, this resulted in a 256% increase in annualized profit (Lichtenberg et al., 2013), with a payback period of less than 1 month on the sensor network (approximately \$6,000). Although perhaps unusual, this study illustrates the compounded economic benefit of increases in efficiency, yield and disease reduction as well as increased turnover of production space.
- J. **Overall Environmental benefits:** We projected environmental benefits with a variety of scenarios for ornamental growers in the US (Majsztrik, Price and King, 2013). For example, using a 50% industry adoption rate in the nursery industry alone, a 50% reduction in water would save enough water for 400,000 households a year, reduced energy usage equivalent to removing 7,500 cars annually, and savings of 282,000 kg of nitrogen and 182,000 kg of phosphorus from entering the environment (Majsztrik et al., 2013). Adoption of the technology in the vegetable, fruit and nut industry would further increase these societal benefits.
- K. **Weather Station (Microclimatic) Data:** Typically we install a "weather station" node that is connected to a number of weather sensors. Although the data are useful to growers to precisely measure their microclimatic conditions on the farm, it is the additional information that the Sensorweb software can calculate that provides very powerful information for farmers (Lea-Cox et al., 2012). This integrated data includes "Degree Days," used for calculating insect emergence rates, and hence timing and targeting pesticide applications appropriately. Chilling hours (predicting bud and flower emergence for fruit growers) can also be easily tracked, enhancing pollination decisions. Leaf wetness measurements can be used to predict disease outbreaks. This information, combined with real-time wind speed and direction data can significantly increase the efficacy of agrochemical sprays, to help avoid costly mistakes. Many additional predictive models are being integrated into the software over time, adding to the value of the information that sensor networks provides farmers, to improve timing, resource use efficiency, productivity and ultimately profitability.
- L. **Extending our Impact to Food Crops; Frost Warnings:** Strawberry production nationally is a \$2.7B dollar industry, with over 70% of the production in Florida and California, where water and nutrient runoff are major concerns. Current research at the University of Maryland is funded by a grant from the Walmart National Sustainable Strawberry Initiative. We are implementing sensor networks in strawberry production, not only to reduce irrigation water and nutrient applications, but also to investigate the utility of sensor networks for frost protection. Since we can sense both leaf and flower temperatures in the canopy, the PlantPoint™ system can not only send out text or voicemail alerts to growers on their phones, but irrigation systems can also be automated for frost protection, starting water applications only when needed.

Much more information on the SCRI-MINDS project and these studies can be downloaded from the project website at <http://www.smart-farms.net/impacts> and from our Knowledge Center at <http://www.smart-farms.org>

## A. Engineering: Hardware and Software Development

During the fifth and final year of this phase of the project, engineering teams at Carnegie Mellon University and Decagon Devices, Inc. developed and implemented commercialization and support plans for the advanced wireless irrigation nodes and continued developing the system to improve scalability and add new features. Further a new company called Mayim, LLC has been created to commercialize the Sensorweb software. Some of the engineering accomplishments are listed below.

- ✓ Developed commercialization & support and plans for this new system
- ✓ Developed & tested new hardware that forms the core of the commercial system
- ✓ Created a new company, Mayim, LLC to commercialize the Sensorweb software
- ✓ Continued support of over two dozen field sites
- ✓ Integrated RFID into Sensorweb for scalable irrigation and crop traceability

### 1. Decagon Devices, Inc.

#### 1.1 Hardware Development

During year 5 of the project, the engineering team at Decagon spent the project development resources creating the commercial version of the irrigation control hardware and software.

Before finalizing the specifications of the commercial system, Decagon engineers took the opportunity to re-examine the approach and architecture of a monitoring and control system optimized for commercial horticultural growers. We conducted interviews with the partner growers to evaluate the positive and negative aspects of the prototype nR5 system. We considered how the commercial system could offer an economical way to scale up use across a whole operation. We also considered how updated hardware could help make the system better.



**Fig. 1 Components of the PlantPoint System.**

The Decagon Devices PlantPoint System consists of wireless monitoring and control nodes, radio gateway, and a SmartBase application appliance. These are described in more detail below.

The engineering team created 3 wireless node types for use in the PlantPoint System. The first node, nM50, has 5 ports for sensors. The nC24-DC and nC24-AC are the control nodes that have two sensor ports and 4 control ports each.

The nM50 is similar to the nR5 node used by the partner growers in the project; however, it has updated hardware with more resources for firmware. This node is designed to just measure sensors so it is easily deployed anywhere in the grower's operation without needing to be close to the irrigation valves. The nM50 has an improved sensor interface that offers better support for current and future Decagon sensors. The improvements include the following features:

1. Support sensors that require always-present excitation (e.g. DS-2 Sonic Anemometer)
2. Auto-detection of Decagon digital sensors to reduce configuration steps and mistakes
3. Flexible storage scheme to support more measurements coming from a digital sensor

The nC24-AC is a sensing and control node designed for use with typical 24VAC solenoid valves. The node's 4 outputs control up to 4 irrigation zones. Through the software, the outputs can also be ganged together if the irrigation zone requires multiple solenoid valves to be actuated at the same time. The nC24-AC requires an external source of 24VAC power to actuate the solenoid valves. The source must be energized while irrigation is needed, but may be shut down when no irrigation is scheduled. While the 24VAC is available, the nC24-AC will harvest a small amount of power to recharge the batteries used to operate the node.

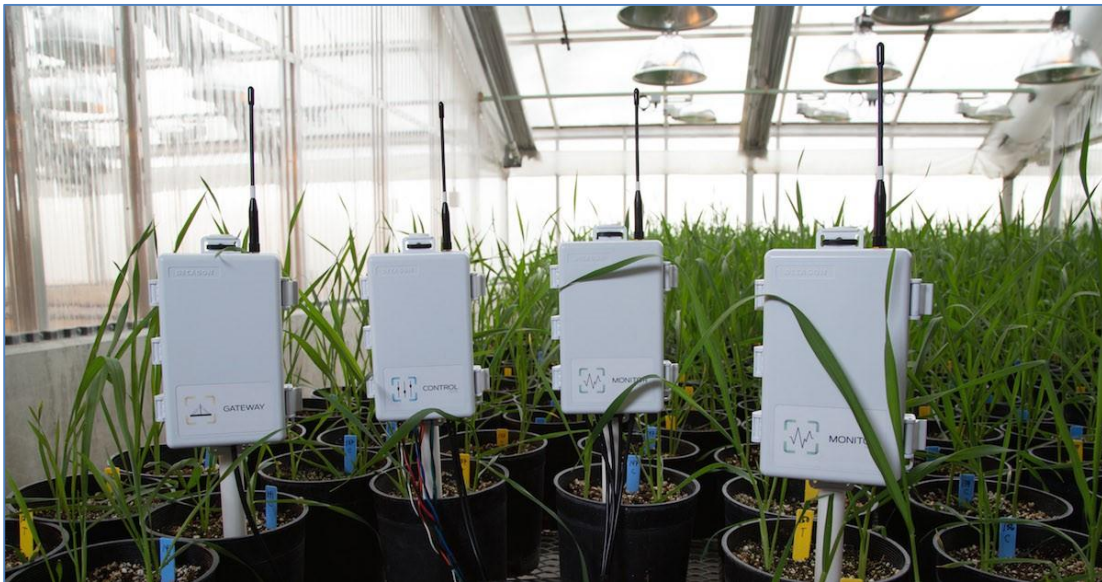

**Fig. 2 PlantPoint Gateway, monitoring, and control nodes.**

The nC24-DC is a sensing and control node designed for use with DC latching solenoid valves. The node's 4 outputs control up to 4 irrigation zones or can be ganged together similar to the nC24-AC node. The nC24-DC node uses its internal battery power to actuate the DC latching valves and doesn't require an external power source. The node has a solar energy harvesting circuitry to recharge the batteries. Both the nC24-AC and the nC24-DC have two sensing ports, which support all the same features as the ports on the nM50. Typically the grower will use these ports to measure sensors co-located near the solenoid valves. This could include a flow meter and in-line electrical conductivity meter.



Decagon engineers also updated the communication protocol used between the nodes and the SmartBase. An important advancement to this protocol is the ability for the node to receive firmware updates over-the-air from the SmartBase. This has the benefit of eliminating the labor associated with applying bug fixes and feature improvement updates to the wireless nodes deployed in the field. These updates happen without interrupting the regular operation of the node.

The purpose of the PlantPoint Radio Gateway is to bridge the radio network of the nodes to the SmartBase appliance via a local area network (LAN). As documented in the year 4 engineering report, the gateway contains a radio module coupled with an Ethernet-enabled microprocessor housed in a weatherproof enclosure. The gateway hardware uses Power over Ethernet technology (IEEE 802.3af) so that only one cable is needed for both communications and power. A PlantPoint installation may have more than one Radio Gateway to provide sufficient coverage to the wireless monitoring and control nodes throughout the commercial growing operation.

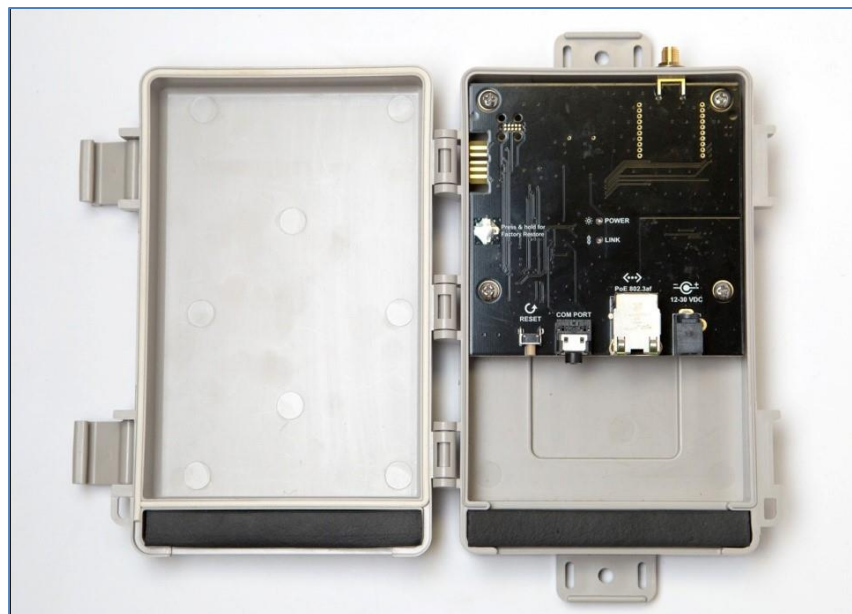

**Fig. 3 Radio Gateway shown in its weather-proof case.**

The PlantPoint system supports data radios operating in different frequencies to allow the system to be compliant to radio use laws around the globe. In the USA and Canada, for example, the radio module uses the 900 MHz license-free ISM band. To support Europe, the system is available with an 868 MHz radio module. These sub-GHz radio modules offer a good balance of range, plant canopy penetration, and power use. For locales that don't have sub-GHz frequency bands available, PlantPoint will use a 2.4 GHz data radio. The 2.4 GHz configuration will have some reduced performance metrics because of the wireless propagation characteristics of this frequency.

The development of the SmartBase hardware started in year 4. During year 5, the Decagon team identified updated components that will offer better performance for the application at the heart of the PlantPoint System.

The SmartBase appliance is built on an industrial computing motherboard. It has no moving parts and is designed to operate 24 hours a day for years, similar to wireless router.

Decagon also adds a simple LCD display board that offers the minimum necessary user interface to help the grower find the full-featured web software GUI. This Decagon-designed LCD module also has integrated watchdog hardware that will reset the system if it becomes unresponsive.



**Fig. 4 PlantPoint SmartBase appliance showing LCD display.**

## 1.2. Decagon Software Development

Developing the PlantPoint application that runs on the SmartBase accounted for the majority of the Decagon engineering work for year 5. The software is built on a solid foundation of data handling, high-performance sensor processing, and a robust communication protocol. The system may be run in a monitoring only mode to provide decision support to the grower or in irrigation control mode that will fully automate the grower’s irrigation. The following is a brief description of some of the important software features of the PlantPoint System.

Configuring the settings for each irrigation zone is handled by a template system in the PlantPoint software. The grower configures common settings in one place and can apply them as appropriate specific to each irrigation zone.

For example, if the grower were using two different growing media, they would define the sensor calibrations appropriate for each media (Fig. 5). The grower then chooses the sensor calibration template as appropriate for each zone. This template system also facilitates necessary changes through the growing season. For example, the grower will define one set of irrigation rules appropriate for the spring and one for the hotter summer months. Switching to the appropriate irrigation rules template as seasons change is quick and easy.

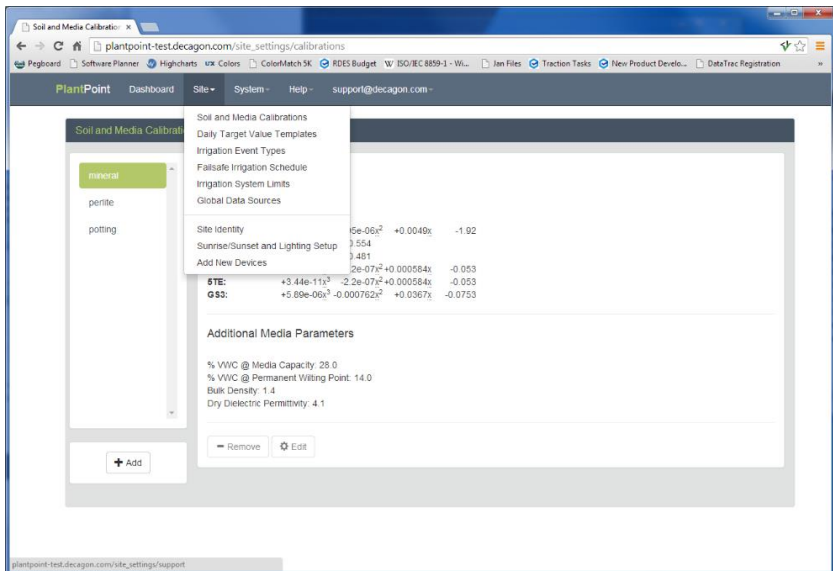

**Fig. 5 PlantPoint application showing media calibration template.**

The earlier nR5-based prototype system used in the project used the concept of local control to enable irrigation. If soil moisture levels fell below a pre-set value, the node would allow irrigation to happen. After interviewing commercial growers, Decagon engineers realized this scheme was too simplistic for many situations in commercial horticulture. The PlantPoint system uses a concept of global control where any number of grower-designated metrics can start an irrigation event for each zone.

A simple example might be that a grower wants to give a short irrigation event to a zone at sunrise regardless of the current water content sensor reading. Then also give irrigation events as needed during the hot time of the day whenever the water content sensor readings drop below a pre-set value. A more complex example might include starting irrigation events based on low water content readings, accumulated solar radiation, or high electrical conductivity sensor readings.

Defining a timer-based irrigation scheme is one aspect of configuring an irrigation zone. This becomes the failsafe schedule loaded into the nC24 nodes controlling irrigation. The fail-safe schedule can be customized for each zone as appropriate for the crop in the zone. In the event a control node loses contact with the system, it will employ the fail-safe irrigation schedule to protect the grower's crop.

The PlantPoint Zone display (Fig. 6) shows the real-time status of the sensor measurements and the irrigation control thresholds. The grower can see on this display when irrigation happened and what event triggered it. The grower can also perform manual overrides to the irrigation events using the Zone Display GUI.

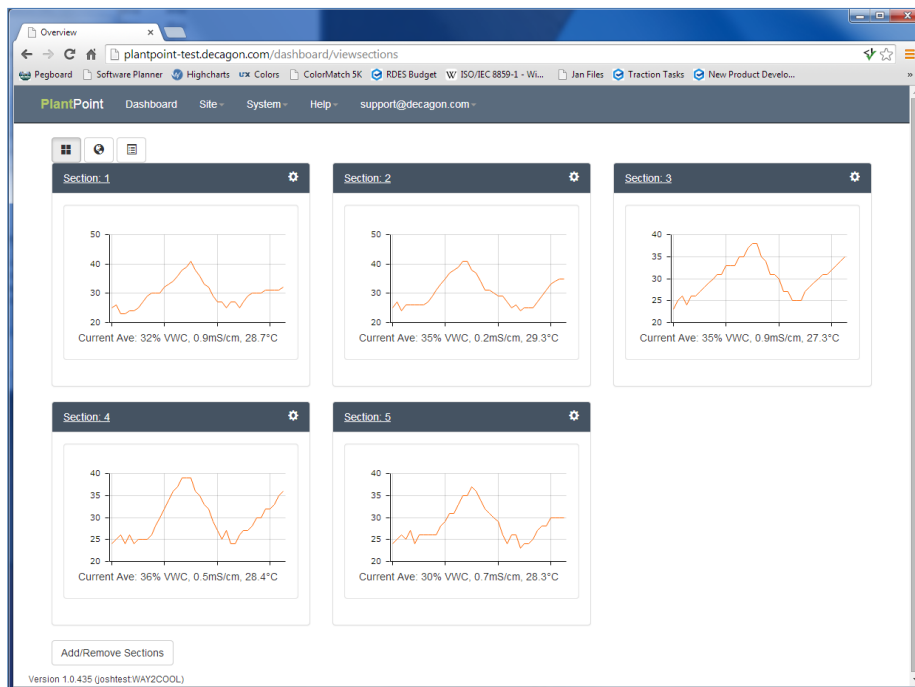

**Fig. 6 PlantPoint application zone overview dashboard.**

PlantPoint offers multiple dashboard views to give the grower the big picture overview of the health and status of their system. This can be a spatial display (Fig 7) showing irrigation zones and wireless monitoring and control nodes on a map. Another dashboard shows the most recent sensor readings and a simple time series to help the grower spot problem zones. A third dashboard shows the operational status of each of the PlantPoint System components (e.g. battery, signal strength, etc.). Each of these dashboards will show icons and messages to alert the grower to problems in their system.

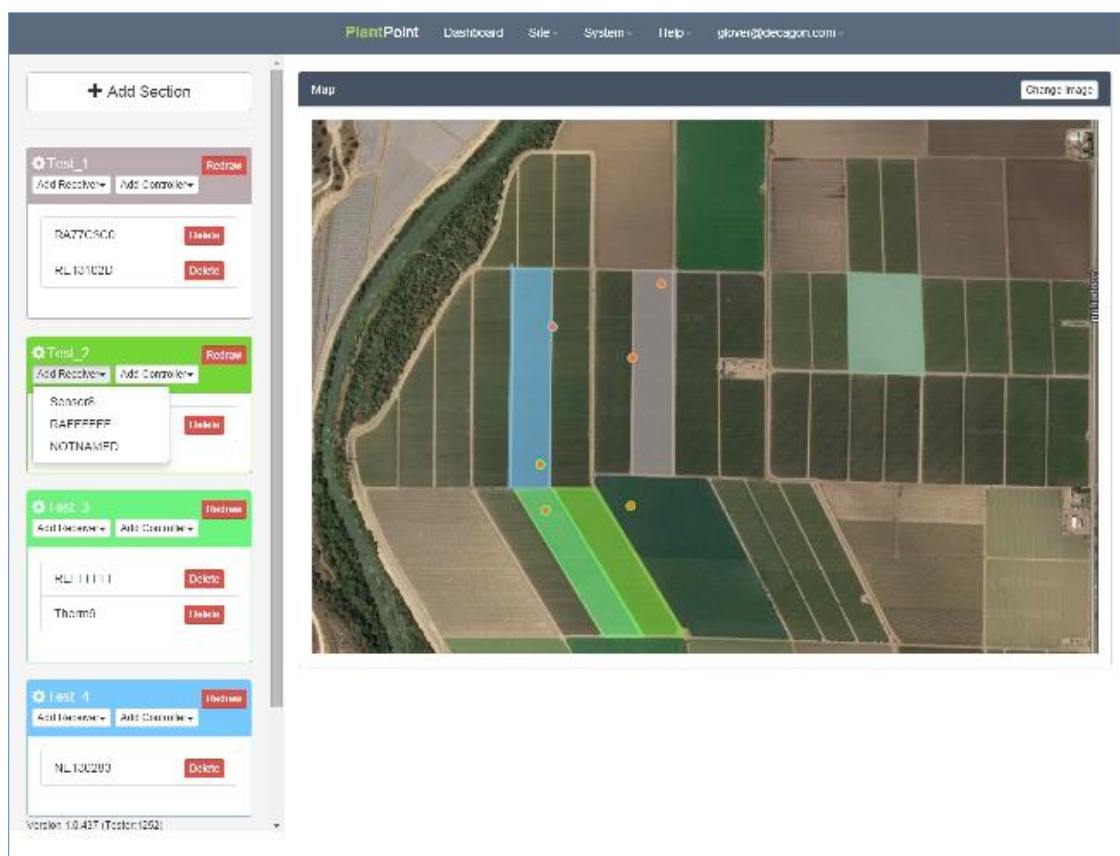

**Fig. 7 PlantPoint application showing spatial dashboard.**

In addition to the status alerts in the dashboard, the PlantPoint System will send alerts to the grower’s mobile device. These alerts can be prioritized and sent to the appropriate member of the grower’s staff. The PlantPoint System includes a graphical data report builder. The grower can use this feature to define charts with data from any sensor in the system. This enables the grower and their consultant to learn from historical data as they tune the system settings. The report feature also allows exporting sensor data for further analysis outside of the PlantPoint application.

The initial PlantPoint System will offer the ability for remote access for support and troubleshooting. Remote access is implemented by a secure, virtual private network (VPN). The grower will customize the configuration of the VPN. Using a VPN, the grower doesn’t require special network configurations from their internet service provider (ISP) or configurations in their internet router to allow remote access to the PlantPoint System.

### 1.3 PlantPoint System Commercial Release

By the end of year 5, the Decagon marketing team had prepared marketing materials for the commercial release of the PlantPoint System (see below). Decagon exhibited the PlantPoint at the following horticulture industry and academic trade shows and conferences.

- American Society for Horticultural Science 2014 (Orlando, FL)
- Citrus Expo 2014 (Ft. Meyers, FL)
- The Landscape Show 2014 (Orlando, FL)
- International Horticulture Congress 2014 (Brisbane, Australia)



**PLANTPOINT**  
BY DECAGON

Looking for a smarter way to irrigate your greenhouse or nursery?  
PlantPoint, a user-friendly integrated hardware and software package from Decagon Devices, offers scalable, wireless, and cost-effective horticultural irrigation management.

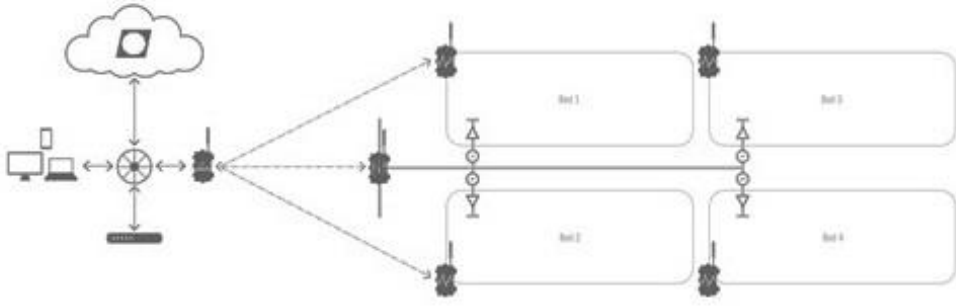

**Legend**

- Monitor Node
- Flow Meter
- Valve
- Gateway
- Control Node
- Radio Connection
- SmartBase
- Network Router
- Ethernet Connection

Smarter Irrigation  
through science

**PLANTPOINT**  
Component Specifications

For More Information  
[PLANTPOINT@DECAGON.COM](mailto:PLANTPOINT@DECAGON.COM)  
(888) 332-2786

**MONITOR NODE**

- mMSO
- 5 sensor ports
- Supports a variety of Decagon Sensors
  - Volumetric water content
  - Soil water potential
  - Electrical conductivity
  - Temperature
  - Flow meters
- 900 MHz ISM license-free Radio Technology
  - 2-3 mile communication range with Gateway
  - 800 MHz ISM license-free radio technology also available (E0)
- Configurable through SmartBase
  - No local configuration required
- Powered by 5 AA batteries

**CONTROL NODE**

- nC24-AC or nC24-DC
- 2 sensor ports
  - For flow meters, electrical conductivity, etc.
- 4 relay ports for valve control
  - Relays available in both 24VAC (nC24-AC) and DC washing services (nC24-DC)
  - Independent or ganged control of relay ports
- Failsafe time-based watering schedule
- 900 MHz ISM license-free Radio Technology
  - 2-3 mile communication range with Gateway
  - 800 MHz ISM license-free radio technology also available (E0)
- Configurable through SmartBase
  - No local configuration required
- Powered by 5 AA batteries with 24V AC charger (nC24-AC) or solar charger (nC24-DC)

**SOFTWARE**

- Simple intuitive graphical user interface optimized for commercial users
- Dashboards with "At-A-Glance" data summary and alerts
- Set point control using multiple variables:
  - Volumetric water content
  - Soil water potential
  - Electrical conductivity
  - Daily cumulative light
- Allows multiple diurnal control periods
  - User definable
- Irrigation decision support tools
  - Plant growth models, etc.
- Web interface for PCs, smartphones, and tablets with on-site and remote access

**GATEWAY**

- Links Monitoring and Control Nodes with SmartBase & local area network
- 100 meter wired communication range with SmartBase
  - 300 m with extenders
- No configuration necessary
  - Auto configuration
- Power and communication over one cable
  - PoE

**SMARTBASE**

- Industrial computer with simple display running PlantPoint software
- No moving parts and wide temperature range tolerance
- Failsafe watchdog functionality with auto restart
- VPN enabled for remote access and troubleshooting



Plot studies with the PlantPoint system deployed in operational greenhouses and nurseries have shown, on average, a 50% reduction in applied water, a 25% reduction in nitrogen runoff, reduced disease losses, and faster production times. For more information on these studies, please visit [DECAGON.COM/ZEOCATION/PLANTPOINT](http://DECAGON.COM/ZEOCATION/PLANTPOINT)

Fig 8. Decagon marketing materials for the PlantPoint System

## 1.4 PlantPoint System Installation, Training and Support

We recognize that while the PlantPoint system is designed to be easy to use and plug-and-play, three principal challenges remain, to provide complete client satisfaction. These include:

1. System design to accomplish specific grower needs and goals,
2. System installation, setup and learning to use the software,
3. Data management that allows a grower to make a decision.

***To minimize these challenges, Decagon works with a trained consultant network. The consultants in this network are “authorized” by Decagon, and will have the following training and business model.***

This model mimics the consultant / distributor network used by Decagon in open-field commercial agriculture.

1. Decagon provides phone and e-mail support, annual training, virtual seminars, and customer visits to the consultants in their network.
2. The consultant works with the grower to determine the best system design for their goals.
3. Decagon sells instrumentation to consultants, as opposed to directly to the grower. The consultant then either sells or rents the instrumentation to the grower, depending on the specific consultant’s business model and the goals of the grower.
4. Consultants include at least one of the following services in their business model:
  - Installation and maintenance of all instrumentation sold,
  - Grower training on instrumentation,
  - Irrigation recommendations at a frequency relevant to the crop being grown, and
  - Other crop consulting as is appropriate for the consultant’s expertise.

## 2. Carnegie Mellon University

### 2.1 Sensorweb Software Development.

During the fifth and final year of this phase of the project, engineering teams at Carnegie Mellon University and Decagon Devices, Inc. developed and implemented commercialization and support plans for the advanced wireless irrigation nodes and continued developing the system to improve scalability and add new features. Further a new company called Mayim, LLC has been created to commercialize the Sensorweb software. Some of the engineering accomplishments are listed below.

- ✓ Developed commercialization & support and plans for this new system
- ✓ Developed & tested new hardware that forms the core of the commercial system
- ✓ Created a new company, Mayim, LLC to commercialize the Sensorweb software
- ✓ Continued support of over two dozen field sites
- ✓ Integrated RFID into Sensorweb for scalable irrigation and crop traceability

The Sensorweb software platform has been developed and tested thoroughly over the past five years. Over the course of this project Sensorweb has grown into a valuable tool for growers and researchers alike. Based on the value that Sensorweb can provide and feedback from existing growers we have decided to commercialize the Sensorweb software in addition to the nodes. The new commercial entity formed is Mayim, LLC which is the Hebrew word for “water”, the crux of this project. Mayim has already signed a license agreement with Carnegie Mellon University for the Sensorweb technology. As part of this commercialization effort Sensorweb is being reworked to be even easier to use with more

information available to growers with just a click, new features to help make Sensorweb more scalable, and new growing tools to let growers get even more value from this system (Fig. 9).



**Fig. 9. Sensorweb Homepage (Dashboard) – Mayim, LLC**

Sensorweb is compatible with the current generation of Decagon nodes and will also be compatible with the new Plant Point monitoring and control that have been commercially released by Decagon Devices.

Mayim, LLC has already sold four systems commercially demonstrating the value of Sensorweb outside the scope of this project that it was developed for. Mayim has also developed strategic partnerships with other companies to help Sensorweb grow and scale to large farms controlling hundreds of irrigation solenoids.

In addition to commercializing the software, new features have been added to Sensorweb. New features include new growing tools and alert capabilities, and radio frequency Identification (RFID) integration. The new tools allow growers to better track water usage and savings. The new alerts make it easier for growers to monitor many different sensors, including flow, which is an important fault detection device. The RFID integration is just starting but it will allow Sensorweb to scale up to many species, and be able to track irrigation settings as a crop is moved.

Adding RFID also has the benefits of allowing growers to track crop locations and conditions from planting to distribution.

Currently Sensorweb has the ability to read RFID tags and enter the tag and the time it was read into its database. As part of the re-design of the Sensorweb user interface, we are looking at different ways to visualize the data from the RFID tags.



Fig. 10. Sample RFID tags that we are evaluating.

## 2.2. Sensorweb Supported Networks

Over the course of this project Sensorweb has been used at many field sites. The table below shows the Sensorweb sites over the course of this project that have been installed and supported.

**Table 1. Sensorweb sites supported by the SCRI-MINDS project, by location**

<p><b>Colorado</b></p> <ol style="list-style-type: none"> <li>Fort Collins</li> </ol>	<p><b>Pennsylvania</b></p> <ol style="list-style-type: none"> <li>Penn State FREC</li> <li>Robot City</li> </ol>
<p><b>Ecuador</b></p> <ol style="list-style-type: none"> <li>Dulcepamba Watershed (EM50G)</li> </ol>	<p><b>Tennessee</b></p> <ol style="list-style-type: none"> <li>Hale &amp; Hines</li> </ol>
<p><b>Georgia</b></p> <ol style="list-style-type: none"> <li>Davis Floral</li> <li>Evergreen Nurseries</li> <li>Garden Design Nursery</li> <li>McCorkle Nurseries</li> <li>Riverbend Nursery</li> <li>Transplant Nurseries</li> <li>UGA Research Greenhouse</li> </ol>	<p><b>Texas</b></p> <ol style="list-style-type: none"> <li>NASA Johnson Space Center Green Roof (EM50G)</li> </ol>
<p><b>Maryland</b></p> <ol style="list-style-type: none"> <li>Flowers by Bauers</li> <li>Moon Nurseries</li> <li>Potomac Plaza Green Roof (EM50G)</li> <li>Raemelton Farm</li> <li>UM Taproots Teaching Network (EM50G)</li> <li>UM Green Roof Network</li> <li>UM Research Greenhouse Network</li> <li>Waverley Farm</li> </ol>	<p><b>Virginia</b></p> <ol style="list-style-type: none"> <li>Lancaster Farms</li> </ol>
<p><b>Ohio</b></p> <ol style="list-style-type: none"> <li>Willoway (Production site)</li> <li>Willoway (USDA site)</li> </ol>	<p><b>Washington</b></p> <ol style="list-style-type: none"> <li>Sunrise Orchard</li> </ol>



## B. Scientific Research and Development

### 1. Colorado State University

In Years 4 and 5, the major effort under this objective was directed at optimization of the MAESTRA model, where:

1. Carbon and water flux responses to physiology by environment interactions were investigated with a sensitivity analysis of climate impacts on biophysical model parameters:
2. The implications of minimum stomatal conductance on estimating water flux in containerized tree nurseries were documented
3. A comparison of the potential for scaling up irrigation scheduling techniques: substrate moisture sensing versus predictive water use modeling was conducted

Figure 11 illustrates the influence of environmental (evaporative demand) and the physiological control exerted by C3 plants on transpiration.

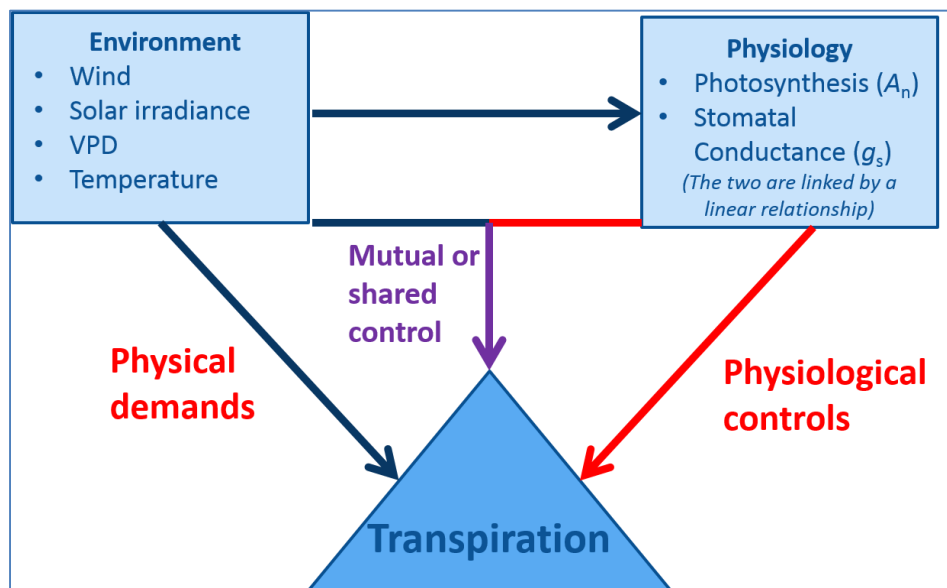

Fig. 11. Influence of Environmental and physiological parameters on plant water use.

To simplify model complexity and scale irrigation predictions to the entire horticulture operation (e.g. one to hundreds of acres) we have focused in on (1) two parameters that we identified to comprise the majority of transpiration prediction power, (2) canopy aerodynamic implications for transpiration estimates, and (3) model versus sensor based irrigation scheduling.

#### 1.1 The implications of minimum stomatal conductance on estimating water flux in containerized tree nurseries.

Stomatal conductance ( $g_s$ ) models are widely used at a variety of scales to predict fluxes of mass and energy between vegetation and the atmosphere. Several  $g_s$  models contain a parameter that specifies the minimum  $g_s$  estimate ( $g_0$ ). Sensitivity analyses with a canopy flux model (MAESTRA) identified  $g_0$  to have the greatest influence on transpiration estimates (seasonal mean of 40%; Fig. 12).

Previously, a spatial analysis revealed the influence of  $g_0$  to vary (30-80%) with the amount of light absorbed by the foliage and to increase in importance as absorbed light decreased.

The parameter  $g_0$  is typically estimated by extrapolating the linear regression fit between observed  $g_s$  and net photosynthesis ( $A_n$ ). However, our measurements demonstrate that the  $g_s$ - $A_n$  relationship becomes nonlinear at low light levels and thus, extrapolating values from data collected in well-lit conditions resulted in an underestimation of  $g_0$  in *Malus domestica* when compared to measured values (20.4 versus 49.7  $\text{mmol m}^{-2} \text{s}^{-1}$  respectively). In addition, extrapolation resulted in negative  $g_0$  values for three other woody species.

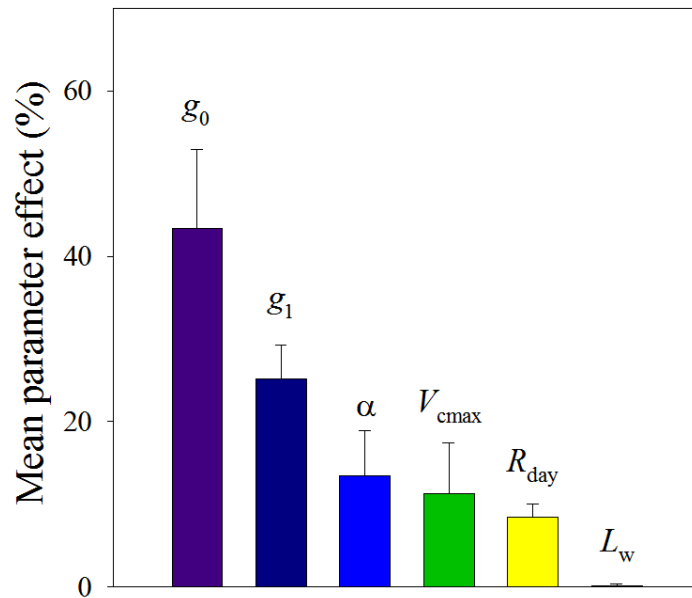

**Fig. 12. Relative importance of model parameters.**

We assert that  $g_0$  can be measured directly with diffusion porometers (as  $g_s$  when  $A_n \leq 0$ ), reducing both the time required to characterize  $g_0$  and the potential error from statistical approximation (Fig. 13). Diffusion porometer measurements offer a viable means to quantify the  $g_0$  parameter, circumventing errors associated with linear extrapolation of the  $g_s$ - $A_n$  relationship.



**Fig.13. Handheld leaf porometer (Decagon Devices, Inc.)**

These results solidify the importance of two key transpiration prediction model parameters at larger scales. The findings will help guide our ability to scale water use estimates at the nursery scale.

*Barnard, D.M. and W.L. Bauerle. 2013. The implications of minimum stomatal conductance on modeling water flux in forest canopies. J. Geophysical Research: Biogeosciences, 118, 1322-1333.*

### 1.2 Seasonal canopy aerodynamics varies among species: Potential implications for transpiration estimates.

The decline in wind speed with depth into plant canopies is often empirically characterized with an exponential extinction coefficient ( $\alpha$ ). Aerodynamic properties of the canopy determine  $\alpha$  and thus variation among species, vegetation type, and canopy development stage can occur. Error in characterizing  $\alpha$  can affect estimates of boundary layer conductance to water vapor ( $g_{bv}$ ), the canopy decoupling coefficient ( $\Omega$ ), and transpiration. Hence, the goals of the current study were to characterize the change in seasonal aerodynamics in four tree species to compare  $\alpha$  calculated from canopy wind profiles to predictions of  $\alpha$  from a simple empirical model, determine the influence of  $\alpha$  on  $g_{bv}$ ,  $\Omega$ , and transpiration, and explain the influence of wind speed on transpiration over a range of environmental conditions using a canopy flux model (MAESTRA). Among species, measured  $\alpha$  varied with wind speed above the canopy ( $U_{3m}$ ) and over the season. Leaf area index ( $LAI$ ) was correlated with  $\alpha$  among species and measurement periods ( $R^2 = 0.78$ ), and the simple empirical model for determining  $\alpha$  was well correlated with measurements ( $R^2 = 0.92$ ). Towards the middle of the season, mean canopy  $g_{bv}$  decreased to 20-50% of early season  $g_{bv}$ , whereas mean canopy  $\Omega$  followed a similar but inverted parabolic trend. Mean canopy  $g_{bv}$  was strongly correlated with  $U_{3m}$  in the lower  $\alpha/LAI$  canopies and with daily interpolated  $\alpha$  in higher  $\alpha/LAI$  canopies. The influence of a discrete increase in wind speed (0.6 to 2.4 m s<sup>-1</sup>) resulted in a wide variation of influence on transpiration estimates (-30% to 20%). We conclude that within canopy variation in wind speed can influence transpiration estimates and  $\Omega$ , thus accurate characterization of  $\alpha$  over the season is integral to preserve transpiration estimate accuracy.

*Barnard, D.M. and W.L. Bauerle. 201x. Seasonal canopy aerodynamics varies among species: potential implications for transpiration estimates. In preparation*

### 1.3 Species-specific irrigation scheduling with a spatially explicit biophysical model: a comparison to substrate moisture sensing with insight into simplified physiological parameterization.

Biophysical models that spatially characterize the photosynthesis-stomatal conductance ( $A_n-g_s$ ) linkage offer a predictive approach to determining species-specific transpiration for irrigation scheduling. However, due to the complexity of physiological parameterization, biophysical models have been impractical for nursery implementation (Fig. 14).

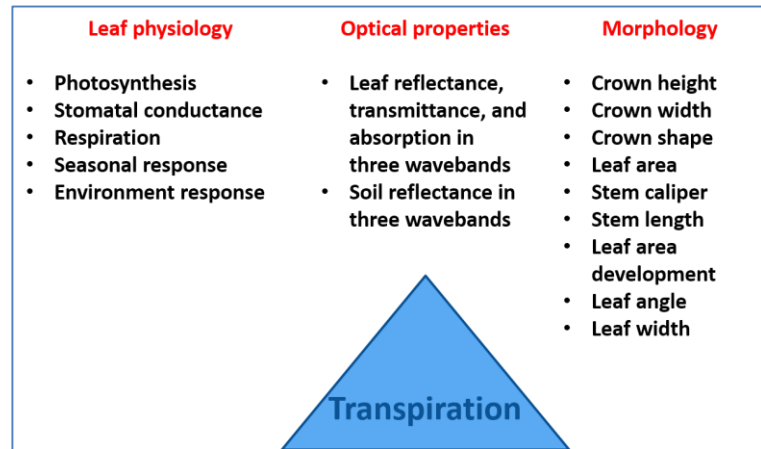

**Fig. 14. Biophysical parameters involved in transpiration**

An alternative to predictive irrigation scheduling is sensing substrate moisture, controlling irrigation based on measured volumetric water content. Directly sensing substrates to aid in irrigation scheduling is increasingly being adopted; thus a comparison with predictive control is warranted. This study had two primary goals: first, we compared the growth (crown leaf area and stem caliper) and irrigation application efficiency ( $e_a$ ) of a predictive scheduling method to a substrate moisture sensing-based method in five deciduous tree species, grown in a containerized pot-in-pot production system (Fig. 15).

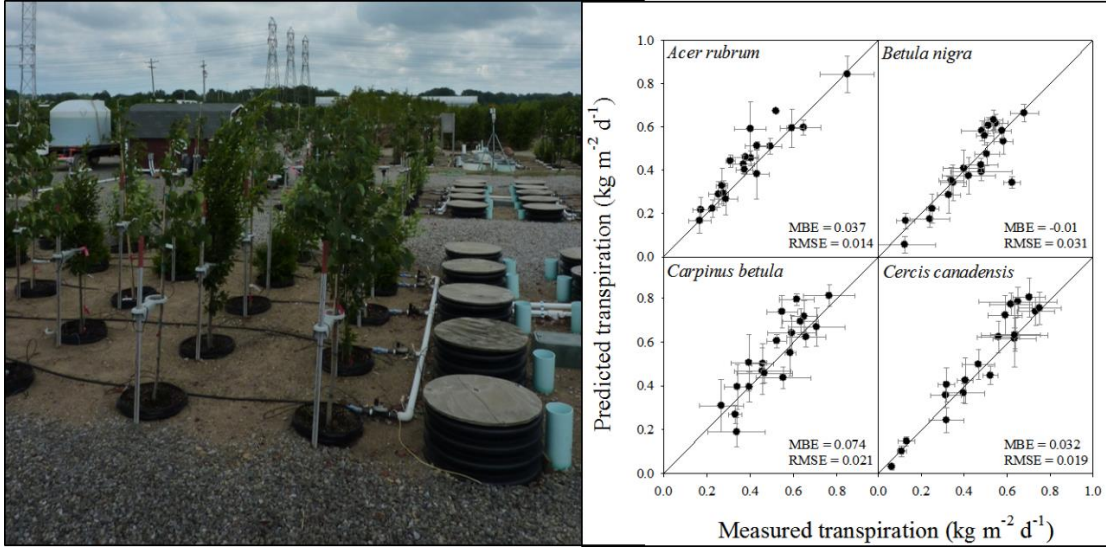

**Fig. 15. Large-scale validation of the MAESTRA model**

Incorporating measured  $g_0$  into MAESTRA (Fig. 16) significantly improved transpiration predictions (6% overestimation versus 45% underestimation respectively), demonstrating the benefit in  $g_s$  models.

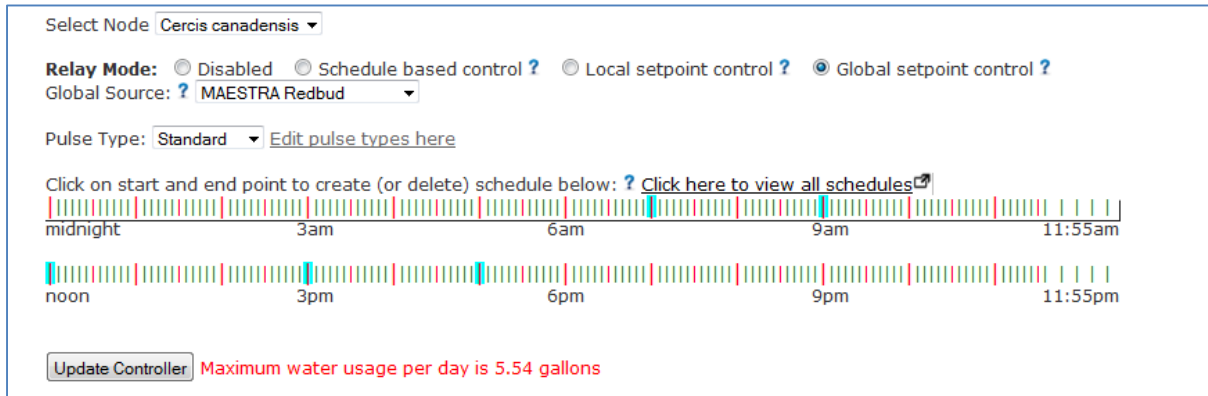
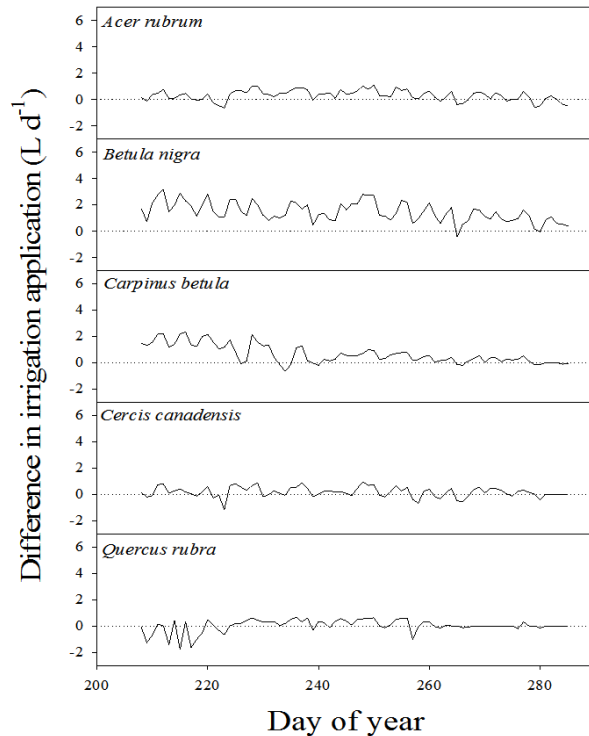

**Fig. 16. Integration of the MAESTRA model into Sensorweb for model-based irrigation scheduling**

The predictive method applied 18-56% more water than the sensing-based method in four species and 6% less in the fifth (Fig. 17). Mean  $e_a$  was 80.1 and 89.5% for predictive and sensing-based treatments respectively. Across species, predictive scheduling yielded 11-53% greater leaf area and 3.4-11% more caliper growth than sensing-based scheduling.

Our second goal was to quantify the loss of transpiration estimate accuracy per species when key species-specific physiology parameter values in the  $A_n$ - $g_s$  scheme were replaced with multi-species means. We found the accuracy of transpiration estimates to depend largely on two parameters:  $g_0$  the minimum stomatal conductance and  $g_1$  the marginal water cost per unit carbon gain.

When only these two parameters were characterized on a species-specific basis transpiration estimates were within 10% error >65% of the time and within 20% error >95% of the time. We conclude that the parameters  $g_0$  and  $g_1$  in the  $A_n-g_s$  scheme are critical to accurate species-specific transpiration estimates and that most other physiology parameters may be generalized, potentially eliminating the need for extensive  $A_n-g_s$  gas exchange experiments to parameterize individual species or varieties



**Fig. 17. Differences in irrigation volumes applied using MAESTRA-based irrigation scheduling compared to sensor (set-point) controlled irrigation.**

[Barnard, D.M. and W.L. Bauerle. 201x. Species-specific irrigation scheduling with a spatially explicit biophysical model: a comparison to substrate moisture sensing with insight into simplified physiological parameterization. In review, \*Agricultural and Forest Meteorology\*.](#)

#### 1.4 General Conclusions from Year 5.

Modeling provides a representation of vegetation biophysical processes that are otherwise difficult to measure directly with equipment. However, it is essential that these processes be accurately represented in modeling frameworks in order to accurately depict interactions between physiology and environment. Hence, the purpose of this final year of work was to improve upon the robust modeling framework of MAESTRA by expanding the understanding of individual parameters, how they interact with the environment, how the model reacts to environmental change, and to ultimately test the predictive ability of the model by applying it in a real-time irrigation system for container grown trees.

In so doing, a comparison between a substrate moisture and predictive technique (i.e. MAESTRA) for scheduling irrigation in container grown trees was conducted in real-time at Willoway Nursery. This is the first study of its type to use a complex model to schedule irrigation. We found that MAESTRA-controlled irrigation produced greater tree growth by determining plant water needs more accurately than the moisture sensing technique. As agricultural water resources decline, these findings will have industry implications for improving irrigation scheduling as growers struggle to improve crop growth efficiency. We also found that, despite the complexity of MAESTRA, a close focus on two key parameters ( $g_0$  and  $g_1$ ) can yield accurate transpiration estimates while minimizing the need for the measurement of extraneous parameters. Hence, other transpiration model parameters for MAESTRA may be simplified with default values, increasing the ease of MAESTRA application in commercial settings.

## 2. Cornell University

The specific short and long-term objectives of this work is to:

1. Determine spatial and temporal variability of soil moisture and soil electrical conductivity to minimize the numbers of sensors required in diverse root environments at various scales
2. Provide micro-scale (root environment) data and integrate it with macro-scale (atmospheric environment) models to predict (i.e. forecast) plant water use;
3. Train undergraduate and graduate students in science and engineering.

Activities	Deliverables	Success Criteria
<p>1. Determine spatial and temporal variability of soil moisture and soil electrical conductivity to minimize the numbers of sensors required in diverse root environments at various scales. Quantify tree response to decreases in soil moisture</p> <p>2. Provide micro-scale (root environment) by relating tree root growth and distribution to sensor variability data and integrate it with macro-scale (atmospheric environment) models to predict (i.e. forecast) plant water use;</p>	<p>1. Data on root system rhizosphere characterization</p> <p>2. Data derived from micro-scale CT to determine root spatial occupation</p>	<p>1. Preliminary data that informs experiments on ornamental tree root response to its rhizosphere environment</p> <p>2. X-ray vision uncovers root-root interactions: quantifying spatial relationships among interacting root systems in three dimensions (in review)</p>

Goals	Deliverables
<p>1. Supplement existing data sets to explain variation in tree responses to soil moisture</p>	<p>1. Data on containerized root growth and exploration and root level shifts in rhizosphere attributes.</p>

### 2.1 Root system rhizosphere characterization

At the individual plant level, water uptake is highly dependent on root distribution (Schenk & Jackson, 2002). However, soil water availability shows high spatial and temporal variation (Göttlein & Manderscheid, 1998; Landsberg & Sands, 2011). Hence, root plasticity in response to fluctuating soil water content may be crucial in order to acquire sufficient resources for survival and growth (Thomas & Weiner, 1989; Casper & Jackson, 1997; Hodge, 2005; Schymanski & Sivapalan, 2008; Padilla *et al.*, 2013). In addition to root growth into areas of high soil moisture, root function influences resource acquisition (Volder *et al.*, 2005). How fast resource uptake and root exudation decline with root age relative to

other species may determine a tree's competitive ability when resources are scarce. Moreover, root foraging depends on plant carbon status and transport, which may be limited during drought depending on plant water use strategy (McDowell *et al.*, 2008).

Plant roots release a tremendous diversity of chemical compounds into the soil including sugars and polysaccharides, organic acids, amino acids, protons, phenolics, fatty acids, sterols, growth factors, flavones, nucleotides, and enzymes (Uren, 2007). Recognizing that transport mechanisms across the root membrane of these different molecules can widely vary, this overall process is termed root exudation. Since it can be challenging to differentiate exudates from other root products such as border cells (Hawes *et al.*, 1998; Hawes *et al.*, 2000), root exudation is often defined as all organic substances and chemicals released into the soil by healthy roots (Rovira, 1969; Grayston *et al.*, 1996).

Since root exudation is the driver of many chemical, physical and microbial rhizosphere processes (Walker *et al.*, 2003), the spatial and temporal dynamics of root exudation are important for improving our understanding of root-soil interactions. The quantity and quality of root exudates are influenced by a variety of plant and environmental factors. First of all, different tree species can show large variation in the amount and composition of chemicals released into the rhizosphere (Shen *et al.*, 1996; Sandnes *et al.*, 2005; Yin *et al.*, 2013), even within the same genus (Smith, 1969). Moreover, tree age and development influence root exudation (Smith, 1970; Groleau-Renaud *et al.*, 1998), and recent evidence suggest this may in turn influence rhizosphere microbial community structures (Chaparro *et al.*, 2013a). On a smaller scale, it is unknown how the age and life span of a specific root affect the movement of exudates into the soil.

In response to plant nutrient status, roots release different chemicals (Hoffland *et al.*, 1992; Zhang *et al.*, 1997; Yoneyama *et al.*, 2007), modifying rhizosphere pH and increasing the availability of soil nutrients (Hoffland *et al.*, 1992). In addition, root exudates can play an important role in shaping bacterial communities around roots (Shi *et al.*, 2011) through influencing rhizosphere pH and redox potential, and releasing antimicrobials or stimulatory compounds such as sugars and amino acids (Hartmann *et al.*, 2009). Root exudates may also function as chemical signals facilitating rhizosphere communication (Perry *et al.*, 2007) like attracting beneficial mycorrhizal fungi (Bouwmeester *et al.*, 2007).

### **Methods:**

Roots with similar lengths and weights but of different ages, as determined by root tracking, were sampled for root exudates using two different collection methods: submerging excavated and cleaned roots in cuvettes with nutrient solutions (Phillips *et al.*, 2008) and placing sorption filters on roots and rhizosphere (Haase *et al.*, 2007; Ohler *et al.*, 2014).

Windows were cut open to access roots (Figs. 18 A, B and C). Following Phillips *et al.*'s method (2008), roots were extensively cleaned with water and put in 30-mL cuvettes filled with glass beads (diameter = 1 mm) and nutrient solution (0.5 mM NH<sub>4</sub>NO<sub>3</sub>, 0.1 mM KH<sub>2</sub>PO<sub>4</sub>, 0.2 mM K<sub>2</sub>SO<sub>4</sub>, 0.2 mM MgSO<sub>4</sub>, 0.3 mM CaCl<sub>2</sub>). Cuvettes were connected to tygon tubing needed for flushing out nutrient solution and exudates using a vacuum pump. After a 2-3 day incubation period, cuvettes were sampled for exudates. The sample was immediately filtered through a 0.22 μm syringe filter and freeze-dried until analysis (Carvalho *et al.*, 2011; Chaparro *et al.*, 2013b). In addition, sorption filters were placed on 2 cm sub-apical root/rhizosphere zones of known age for 4 hours.

Filters are stored in freezer at -20°C until extraction with 80% methanol. During extraction, filters were removed by centrifugation. Using a speed vac concentrator, supernatant was dried at 30°C and subsequently stored for further analysis.

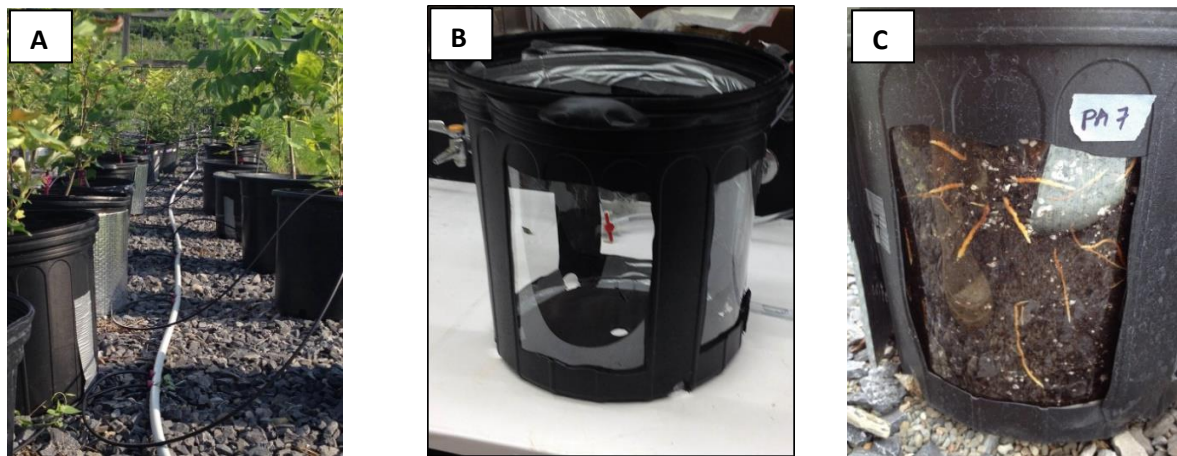

**Fig. 18. Container set-up (A) of fabricated containers with mylar windows (B) and characteristic root growth on the mylar windows that allow for sampling root exudates and rhizosphere conditions (C).**

For quantitative and qualitative analyses of exudates by GC-MS, dried samples from both methods will be dissolved in a 200  $\mu\text{L}$  methanol solution and subjected to a two step derivatization using 25 $\mu\text{L}$  methoxyhydroxymethylamine (20 mg/mL pyridine) and 50  $\mu\text{L}$  MSTFA with incubation periods of 2 hrs and 30 min at 37°C. In addition, a mixture of fatty acid methyl esters with a chain length of C8-C30 were added as internal retention index. One  $\mu\text{L}$  of each sample will be analyzed with a gas chromatograph coupled to an Ion Trap MS. A Rxi®5Sil MS Integra column (Restek, 0.25 mm ID, and 0.25  $\mu\text{L}$  fil thickness) was used for separation (Chaparro *et al.*, 2013a; Ohler *et al.*, 2014).

## 2.2 Further work on CT imaging to measure root traits belowground

Plant roots growing within a finite amount of space will inevitably interact with each other in the pursuit of essential resources. Common parameters that quantify the effect of belowground interactions on root growth dynamics include fine root abundance, spatial/temporal deployment, growth rate, and diameter class (Casper and Jackson, 1997; Eissenstatt and Yanai, 1997; Eissenstatt *et al.* 2000, Kembell *et al.* 2008; Hodge, 2009). While parameters such as these differ across species, accurate observations are inherently limited by the opaque and heterogeneous nature of soil matrices, and generally require a destructive harvest of roots (Joslin and Henderson, 1982; Steingrobe *et al.* 2000), or visualization along a two dimensional (2D) surface (Gross *et al.* 1992; Majdi, 1996; Eissenstatt *et al.* 2000).

However, recent advances in three dimensional (3D) imaging technology such as ground penetrating radar, laser imaging, nuclear magnetic resonance imaging (MRI), neutron radiography (NT), and X-ray computed tomography (CT) have made the observation of undisturbed root systems possible (Macfall *et al.* 1991; Butnor *et al.* 2001; Gregory *et al.* 2003; Kaester *et al.* 2006; Perret *et al.* 2007; Tracy *et al.* 2010; Moradi *et al.* 2011; Mairhofer *et al.* 2012). Further innovations in software such as *Rootviz*, *Root track*, *RootReader3D*, and *Avizo* (Saoirse *et al.* 2010; Tracy *et al.* 2010; Clark *et al.* 2011; Mairhofer *et al.* 2012), and specific filtering algorithms (Perret *et al.* 2007) have improved 3D image resolution and stream-lined the quantification of anatomical parameters such as lateral root length, lateral root number, root-system surface area, and volume of undisturbed root systems. With every technological advancement, the scope of viable research questions and objectives continue to develop. For example, studies have already begun to explore the 3D spatial distribution of fine and coarse roots in forests (Pierret *et al.* 1999, Butnor *et al.* 2001), mechanical buckling in plant roots (Silverberg *et al.* 2012), and water uptake at the root-soil interface (Moradi *et al.* 2011).



We also developed a series of belowground metrics that took advantage of the full 3D information, and quantified spatial relationships among root tips and root volume: a data set inaccessible with a 2D approach. Our initial experiments utilized a common deciduous (Poplar) and evergreen (Spruce) tree species to determine the outcome or root growth for these to tree “functional types”. The experiment was a subset of a larger experiment that examined the change in root growth when solitary versus multiple tree species are grown in shared confined space. Hence data are often reported as intra (same species) inter (two different species) or control (solitary tree species). For the purpose of this grant the solitary tree species is of the highest importance.

Irrigation was terminated after two months of growth. Plants were allowed to transpire residual water remaining in each container for two days prior to imaging in order to reduce imaging artifacts. Plants were then transported Cornell’s imaging facility for CT scanning.

Root surface area was determined from the 3D data sets by sequentially analyzing each x-y cross-section with MATLAB’s *bwtraceboundary* function. This identified the coordinates of the root perimeter from which we calculated the circumference of all roots passing through the plane. The circumference was multiplied by the cross-sectional thickness (100  $\mu\text{m}$ ) to estimate root surface area per image slice. This was performed for all cross-sectional images and the results summed to calculate root system surface area. Root system volume was calculated by summing the total number of occupied voxels and multiplying by the volume per voxel,  $10^{-3} \text{ mm}^3/\text{voxel}$  (Fig. 19).

**Fig. 19. With a 3D skeleton the effect of treatment on root system architecture and space exploration can be quantified.** Two such metrics were radial density and the major/minor radii.

For each of these metrics, the x,y,z coordinates of every point on a root system was used to determine the central mass or central position for each of the 1400 cross sectional images.

The radial distribution of the root system volume (or root tips) are measured relative to center mass, and the average of this is the radial area of root tips.

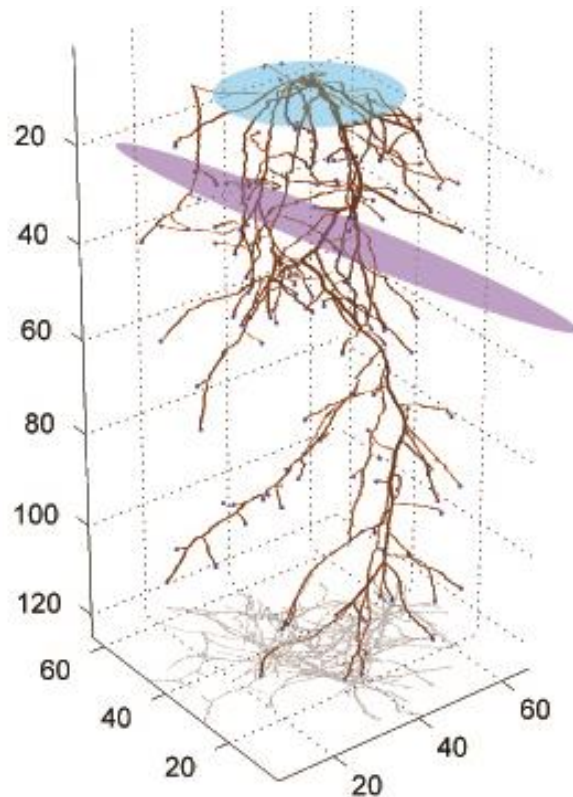

Following X-ray scanning, plants were destructively harvested. Leaves/needles and petioles were removed from the main stem and scanned using a photo scanner (Epson Expression 10000XL, 2400 dpi, Epson America Inc., Long Beach CA). Directly following the removal of aboveground tissues, acrylic containers were inverted and tamped to release the polystyrene medium along with roots, which were

gently rinsed under a 0.5 mm sieve. Polystyrene beads still attached to roots were removed using forceps. Individual roots were separated manually to prevent overlapping segments, placed on a photo scanner, and scanned. After scanning, above and belowground tissues were placed in separate paper bags, dried at 55 C for three days, and then weighed. Scanned images were analyzed for leaf surface area, root surface area, and total root length using *WinRhizo* (Winrhizo 2011, Regent Instruments, Canada). The number of root tips were counted manually using *ImageJ*.

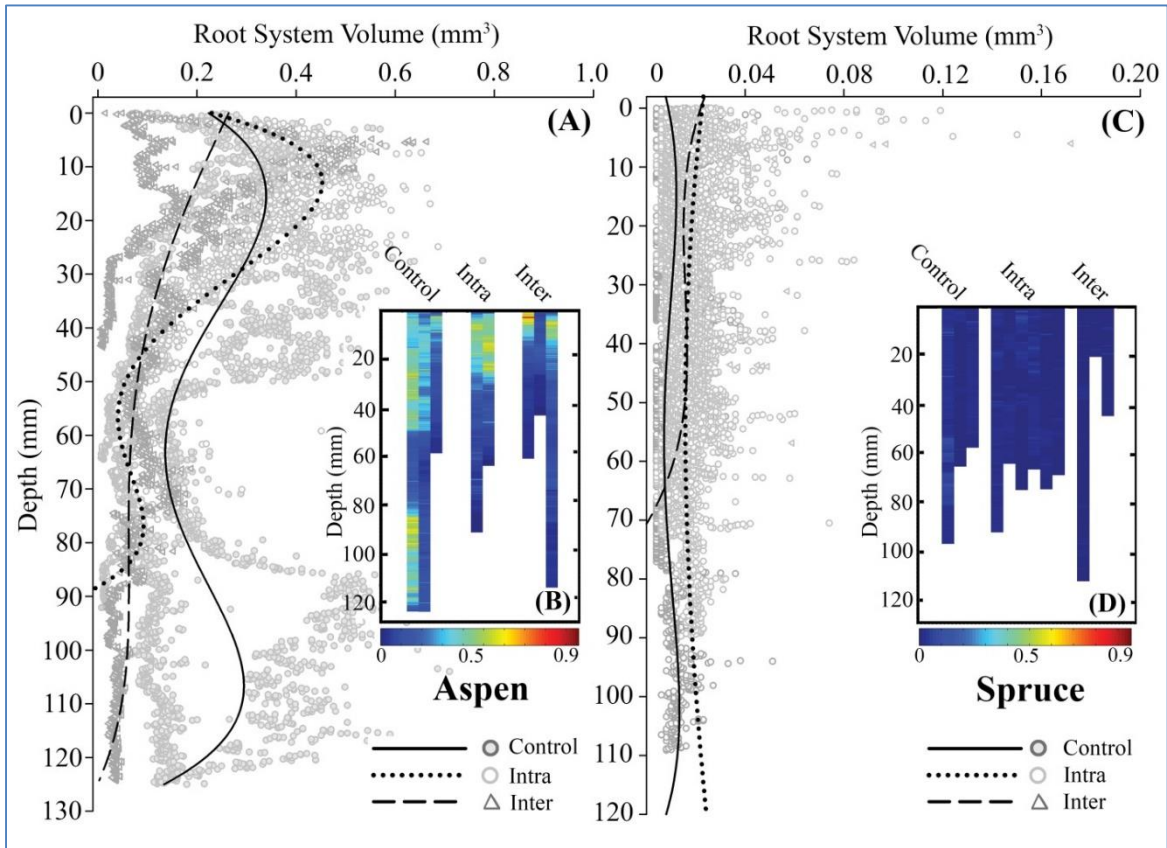

**Fig. 20.** Root system volume as a function of depth. **A, C:** scatter plots of aspen (*Populus tremuloides*) and spruce (*Picea mariana*), respectively. Aspen’s data was fit to a fourth order polynomial (Eq. 2): control (solid line,  $R^2 = 0.21$ ;  $P < 0.0001$ ), intra-specific (dotted line,  $R^2 = 0.86$ ,  $P < 0.0001$ ), and inter-specific (dashed line,  $R^2 = 0.50$ ;  $P < 0.0001$ ). Spruce’s fit to a fourth order polynomial was: control (solid line,  $R^2 = 0.07$ ;  $P < 0.0001$ ), intra-specific (dotted line,  $R^2 = 0.03$ ,  $P < 0.0001$ ), and inter-specific (dashed line,  $R^2 = 0.20$ ;  $P < 0.0001$ ).

**Inset Graphs B, D:** Heat map representing root system volume as a function of depth for aspen and spruce, respectively. Heat map units are in  $\text{mm}^3$ . Each striated column represents the full root volume of a single seedling. Note the differences in axes.

In our experiment using *Picea mariana* (spruce) and *Populus tremuloides* (aspen), we successfully rendered between 62-76% of the actual root system architecture. We believe that roughly 30% of the root systems were lost in the annotation phase of the methodology because of the criteria we followed for each annotation. Specifically, roots that contacted the container wall were to be excluded on the basis that these roots will behave uncharacteristically, i.e. container circling. Also, it was often the case that roots that contacted the container wall were unperceivable due to similarities in X-ray attenuation.

This criterion, while preserving the “unimpeded” growth of roots, led to a loss in significance of treatment on root system architecture. Specifically, the significant effect of treatment on destructively measured root system biomass and surface area was absent in the 3D reconstruction (3D volume or 3D surface area).

Solitary aspen tended to distribute their root tips evenly across vertical space, and occupied an average depth of  $58.6 \text{ mm} \pm 1.43 \text{ mm}$  (Fig. 20). The average depth of spruce control root tips was  $45.2 \pm 6.56 \text{ mm}$ . By spatially segregating root volume from root tips, a plant can occupy an exclusive volume of space while simultaneously foraging for resources, all the while reducing competition with itself. Therefore, when quantifying root growth dynamics in 3D volumes, either in response to itself or a given treatment, special attention should be paid to the dynamic growth and placement of root tips independently of whole root systems.

### 3. University of Georgia

#### 3.1 New technology development

The University of Georgia team developed a [new irrigation/fertigation system](#) that can irrigate and fertilize plants on-demand. The system uses sensors that can measure substrate water content and electrical conductivity (EC) (GS-3, Decagon Devices). These sensors are connected to a datalogger (CR1000, Campbell Scientific). The datalogger measures 16 sensors and for each sensor then determines if the measured water content and EC are below specific thresholds for that particular plot. Since EC can be used as a proxy for fertilizer concentration in the substrate, those readings are used to determine whether fertilization is needed. If the water content and EC are both below their respective thresholds, the plants are fertigated (watered with a fertilizer solution) and if only the water content is below the threshold, the plants are irrigated with tap water. The system is capable of controlling irrigation and fertigation of 16 separate plots. Performance of the system is currently under evaluation with a crop of hellebores.

The University of Georgia team designed and built a [cheap, automated irrigation system](#) using an Arduino Uno microcontroller, capacitance soil moisture sensors, and solenoid valves. This system effectively monitored and controlled VWC over a range of irrigation thresholds (0.2, 0.3, 0.4, and  $0.5 \text{ m}^3 \text{ m}^{-3}$ ) in potted *Hibiscus acetosella* ‘Panama Red’. The microcontroller can be used with both regular 24 VAC solenoid valves and with latching 9 VDC solenoids valves. The technology is relatively inexpensive, accessible, and required little maintenance over the course of a 41-d trial. The low cost of this irrigation controller makes it useful in many horticultural settings, including both research and production.

#### 3.2 Measuring Electrical Conductivity

Electrical conductivity (EC) is commonly used as an indicator of fertilizer levels in soilless substrates. The EC can be determined as bulk EC (bEC, the EC of the combined solid, water and air phases) and as pore water EC (pwEC, the EC of the solution in the substrate). Since pwEC represents the EC of the solution that roots are exposed to, this measurement is more relevant for crop production. In situ EC sensors can simplify EC measurements and allow for continuous monitoring of substrate fertility level over time. However, these sensors generally determine bEC. Hilhorst developed a model to estimate pwEC from bEC and dielectric permittivity ( $\epsilon_b$ , directly related to substrate volumetric water content [VWC]). One of the parameters in the Hilhorst model is the permittivity of dry soil/substrate ( $\epsilon'_{\text{sb}=0}$ ), which is assumed to be similar for different soils/substrates. However,  $\epsilon'_{\text{sb}=0}$  may depend on the dielectric properties of the substrate and the measurement frequency of the dielectric sensor. Our objective was to determine

$e'_{\text{ob}=0}$  using four different sensors to optimize pwEC measurements in two soilless substrates (peat:perlite and peat:vermiculite).

We collected data in both substrates, using a wide range of substrate VWC (0.22 to 0.55  $\text{m}^3\cdot\text{m}^{-3}$ ) and three different fertilizer levels (0.5, 1.5, and 2.5  $\text{g}\cdot\text{L}^{-1}$ ) to get a broad range of pwEC values. Substrate temperature,  $\epsilon_b$ , and bEC were measured with four different sensors (GS-3, Decagon Devices; HydraProbe II, Stevens Water Monitoring Systems; SigmaProbe and WET-2, Delta-T). A small amount of substrate solution was subsequently sampled using a juice press and the EC of this solution was measured. The solution EC was assumed to represent pwEC. These data were used to back solve the Hilhorst equation to calculate  $e'_{\text{ob}=0}$ . We found that  $e'_{\text{ob}=0}$  is not a constant and depends on  $\epsilon_b$ , bEC, and their interaction. The value of  $e'_{\text{ob}=0}$  also differed among sensors and substrates. More accurate estimates of  $e'_{\text{ob}=0}$  can result in more accurate pwEC measurements. Evaluation of our approach with an independent data set suggests that accuracy of pwEC measurements differs among sensors, with the GS3 performing worse than the Stevens Hydraprobe and Delta T's Sigmprobe and WET sensor. The relative poor performance of the GS3 sensors may be due to the low  $\epsilon_b$  values measured in soilless substrates. This low  $\epsilon_b$  makes very precise determination of  $e'_{\text{ob}=0}$  more important, which can limit sensor performance.

### 3.3 Modeling Evapotranspiration

The UGA team collaborated with David Kohanbash at Carnegie Mellon on the incorporation of evapotranspiration (ET) modeling into Sensorweb. Marc van Iersel checked the programming code and subsequently tested the resulting grower tool.

Figure 21 shows ET as calculated by Sensorweb for a site near the UGA research greenhouses (Riverbend Road, Athens, GA, x-axis) and ET data from the nearest UGA weather Station (Horticulture Farm, Watkinsville, GA; y-axis). Although there is a highly significant ( $P < 0.00001$ ) correlation, it is not as strong as we hoped. This may be due to the location of the weather station at the research greenhouses, where wind may have been partly blocked by the greenhouses while there could be some reflected light from the greenhouses that affects radiation measurements.

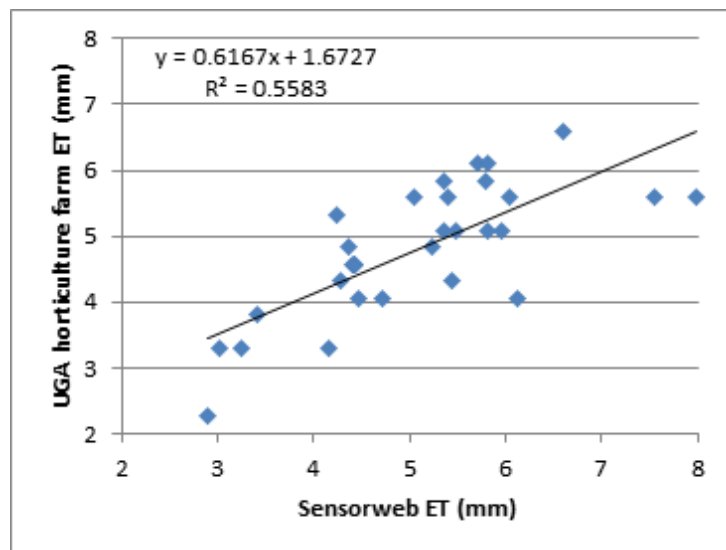

Fig. 21. Comparison of predicted vs. measured ET

### 3.4 Production research: Plant quality

Using time-lapse photography, the UGA team studied diurnal elongation patterns of *Hibiscus acetosella*. Elongation is most rapid at night and especially shortly after the onset of darkness. Exposing plants to drought stress reduces elongation rates, and elongation rates do not immediately recover to the rate of unstressed plants after the plants are re-watered.

Using tomato as a model crop, the UGA team is studying the role of gibberellins on drought-induced reductions in elongation rates. Tomato plants were grown under well-watered and drought-stressed conditions and some plants were treated with gibberellin biosynthesis inhibitors. Internode tissue has been collected for quantification of gibberellin mRNA concentrations. These samples are currently being analyzed. The results will be used to relate plant morphological responses to genetic and hormonal processes.

**Height regulation** is crucial in many ornamental species, including poinsettia (*Euphorbia pulcherrima*) production for both aesthetics and postharvest handling. Controlled water deficit (WD) offers a potential alternative to plant growth retardants (PGRs) for poinsettia height regulation. We have previously shown that WD can be used to regulate poinsettia stem elongation. However, it is not clear what the limits are for height control using WD and how it may affect aesthetic qualities, such as bract size. Our objectives were to determine how much shoot elongation can be inhibited using controlled WD and to investigate possible adverse effects of WD on shoot morphology. Rooted cuttings of poinsettia 'Classic Red' were transplanted into 15 cm pots filled with 80% peat: 20% perlite (v/v) substrate. Three target heights (43.2, 39.4 and 35.6 cm) were set at pinching and height tracking curves were used to monitor plants throughout the production cycle. Substrate volumetric water content ( $\theta$ ) was maintained at  $0.40 \text{ m}^3 \cdot \text{m}^{-3}$  (a matric potential of approximately -5 kPa) during well-watered conditions and reduced to  $0.20 \text{ m}^3 \cdot \text{m}^{-3}$  (approximately -75 kPa) when plants were taller than desired, based on the height tracking curves. Control plants were maintained at a  $\theta$  of  $0.40 \text{ m}^3 \cdot \text{m}^{-3}$  throughout the study and had a final height of 51.2 cm.

Plants with the 35.6 cm target height exceeded the upper limits of the height tracking curve despite being kept at a  $\theta$  of  $0.20 \text{ m}^3 \cdot \text{m}^{-3}$  for 70 d after pinching and had a final height of 39.8 cm. The final plant heights in the 39.4 and 43.2 cm target height treatments were 41.3 and 43.5 cm respectively, within the 2.5 cm margin of error of their respective target heights. Relative to control plants, bract area was reduced by 53, 47 and 31% in the 35.6, 39.4 and 43.2 cm target height treatments, respectively. Our results indicate that the minimum height that can be achieved using WD is approximately 39-40 cm for this cultivar, a reduction of 11.5 cm compared to control plants, but WD may also decrease bract size.

### 3.5 Production research: Irrigation and fertilization

The UGA team conducted a study to measure light interception and quantify its effects on water use of four bedding plant species (impatiens, *Dianthus chinensis*, *Petunia xhybrida* and ageratum). Canopy percentage light interception ( $IL_{\%}$ ) was measured regularly using a ceptometer (AccuPAR LP-80, Decagon Devices). The daily of light interception ( $IL_{\text{daily}}$ ) for each crop was calculated from canopy  $IL_{\%}$  and the daily light integral (DLI). Daily water use (DWU) was calculated from the number of irrigation events recorded by a data logger. Across all the four bedding plants  $IL_{\text{daily}}$  (% light interception \* DLI) and the interaction of  $IL_{\text{daily}}$  and vapor pressure deficit (VPD) explained 75% of variation in DWU. However, DWU of petunia and impatiens was more strongly correlated with light interception ( $r^2 = 0.83$  and  $0.87$ , respectively) than that of dianthus and ageratum ( $r^2 = 0.64$  and  $0.67$ , respectively). Accurate light interception data may be harder to collect in species like ageratum and dianthus (with a more creeping growth habit) than in impatiens and petunia (with a more upright habit), thus affecting the correlation between measured light interception and water use. To circumvent this issue, we hope to use spectral reflectance, rather than light interception as a measure of canopy size in future studies.

Fertilizer leaching has a negative environmental impact as the leached nutrients enter into local ecosystems. It can also necessitate additional fertilizer applications, which is costly for growers. More efficient irrigation can reduce the leaching of fertilizers, potentially reducing fertilizer requirements while benefitting the environment. Our objective was to determine the effect of fertilizer rate and

irrigation volume on pore water EC, leachate volume, electrical conductivity (EC), and nutrient concentrations, as well as growth of *Gardenia jasminoides* Heaven Scent®. Treatment combinations included fertilizer rates of 100 (40 g/plant), 50 (20 g/plant), and 25% of bag rate (10 g/plant) and irrigation volumes of 66, 100, 132, or 165 mL per irrigation event for a total of 12 treatment combinations. Soil moisture sensor-controlled, automated irrigation was used to irrigate when the control treatment (66 mL irrigation treatment, 100% fertilizer treatment) reached a volumetric water content of  $0.35 \text{ m}^3 \cdot \text{m}^{-3}$ . All irrigation events for a replication occurred at this time with the 66, 100, 132, and 165 irrigation volume treatments being applied with 2, 3, 4, and 5 minute irrigation intervals.

Fertilizer rate had a greater effect on growth of *Gardenia jasminoides* Heaven Scent® than irrigation volume with the 25% fertilizer rate resulting in significantly lower shoot dry weight (18.7 g/plant) than the 50 and 100% rates (25.3, and 27.3 g/plant respectively). Growth index was also higher for the 50% and 100% fertilizer rates. Leachate volume varied greatly over the course of the growing season due to rainfall. Irrigation volume effects were the most evident in the 3<sup>rd</sup>, 8<sup>th</sup>, and 9<sup>th</sup> biweekly leachate collections, in which there was minimal or no rainfall. For these collections there was less than 130 mL of leachate for the 66 mL irrigation treatment with leachate volume increasing by 56%, 58%, and 48% from the 66 to 100, 100 to 132, and 132 to 165 mL irrigation treatments, respectively.

Pore water EC, leachate EC,  $\text{NO}_3\text{-N}$  quantities, and  $\text{PO}_4\text{-P}$  quantities were all highest with the 100% fertilizer rate, with the 66 mL irrigation treatment having the highest leachate EC for all fertilizer treatments. Cumulative leachate volume for the 66 and 100 mL irrigation treatments were not affected by fertilizer rate while the 132 and 165 mL had greater leaching at the 25% fertilizer rate. Lower irrigation volumes resulted in reduced water and nutrient leaching and higher leachate EC. The higher leachate EC was the result of higher concentration of fertilizers in less volume of leachate. The results of this study suggest that reduced fertilizer rates up to 50% and more efficient irrigation can be used to produce salable plants with reduced leaching and thus less environmental impact.

We also conducted a study with several hundred *Rudbeckia* 'Goldsturm' on a single greenhouse bench. All plants were irrigated using highly uniform Netafim pressure-compensated drip emitters. An nR5 control node with five EC-5 soil moisture sensors was used to monitor five of the pots. Pots were kept near saturation for the first 16 days (Fig. 22; horizontal arrow) and then allowed to go through three gradual dry down cycles (vertical arrows indicate rewatering). Variability among the readings from the five soil moisture sensors greatly increased as the substrate water content decreased. This was highly repeatable and presumably due to differences in water use among the five different plants. Those differences in water use may be due to differences in plant size or micro-environmental gradients along the greenhouse bench. We also have data from many of the other pots used in this study, collected with a Campbell Scientific logger, but those data have not yet been analyzed.

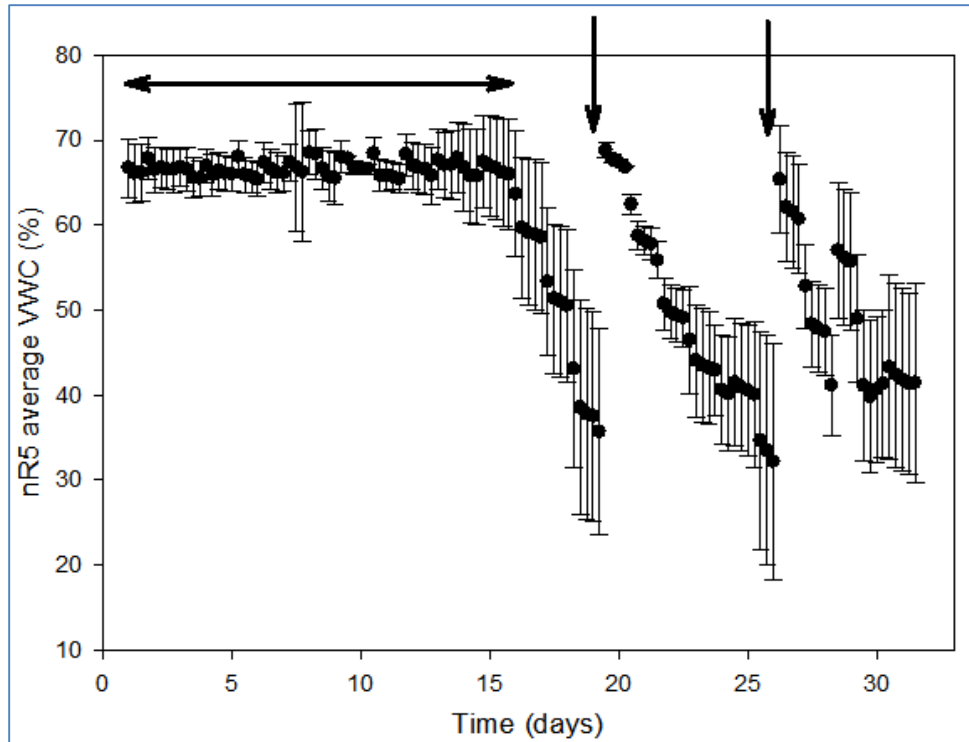

**Fig 22. Soil Volumetric Water Content (VWC) for Rudbeckia ‘Goldsturm. Pots were kept near saturation for the first 16 days (horizontal arrow) and then allowed to go through three gradual dry down cycles (vertical arrows indicate re-watering).**

### 3.6 On-Farm Work

We have supported the use of wireless sensor networks for irrigation control in three commercial nurseries, Evergreen Nursery (Statham, GA), McCorkle Nurseries (Dearing, GA), and Garden Design Nursery (Danielsville, GA). Personnel at Evergreen and McCorkle Nurseries has become familiar enough with the system to do all day-to-day operations and moves nodes among locations. The production area controlled by the sensor network at Evergreen now includes a large new area that is used mainly for hellebores. Initial results have been positive, with this year’s crop performing much better than last year’s (before the sensor network was used).

In addition to ongoing trials in the nurseries with two of the grower partners in the SCRI-MINDS project (McCorkle and Evergreen Nurseries; see section 5 ‘Other products’), we have also worked with Garden Design Nursery (which received a free sensor network for participating in a grower survey) and with two new research partners, Transplant Nursery in Lithonia, GA and Davis Floral Greenhouses and Dewy Rose, GA. Our work at the latter two operations is funded through specialty crop block grants and has allowed is to showcase the wireless sensor networks in two additional operations. We are studying nutrient and disease management in these two operations.

### 3.7 Opportunities for training and professional development

Five students (two MS and three PhD) have been involved in this project at the University of Georgia in the last year. These students have been exposed to the latest wireless sensor network technology and have been involved in scientific research related to this project. Four of these students had the

opportunity to attend the 2014 meeting of the American Society for Horticultural Science in Orlando, FL. The students all gave oral presentations about their research, attended many other scientific sessions, and networked with horticultural scientists.

Over the course of this 5-year project, three graduate students have received PhD degrees: Jongyun Kim, Alem Peter, and Mandy Bayer. Lucas O'Meara received a MS degree, while Alex Litvin is scheduled to complete his MS in spring 2015. Will Wheeler is scheduled to receive an MS degree in 2016 and he is working on a project that is a direct off-shoot of this SCRI project (funded by a specialty crop block grant). Rhuanito Soranz Ferrarezi has received training first as a visiting PhD student (on a one year scholarship from the Brazilian government) and subsequently as a post-doc. Three undergraduates have participated in this project.

### 3.8 Dissemination of Results to Communities of Interest

**Growers: Online Knowledge Center.** Matthew Chappell has taken the lead on getting team members to contribute learning modules for the project's knowledge Center ([www.smart-farms.org](http://www.smart-farms.org)) and has overseen the peer review process. The UGA team has developed three learning modules: 'What is a sensor network', 'All about sensors' and 'Weather stations'. These learning modules are publicly available. A fourth module 'Interpreting sensor data' is currently under development.

**Growers: presentations and workshops at trade shows,** including the Lower Mainland Horticulture Improvement Association, Pacific Agriculture Show, Abbotsford, BC, Canada; Cultivate '14, the largest greenhouse trade show in North America, nursery IPM workshops in Tennessee and North Carolina, and an irrigation workshop in Lleida, Spain. Learning modules to help growers learn about system installation, capabilities and potential benefits are currently under development and are posted on [www.smart-farms](http://www.smart-farms) following peer review.

**Training of undergraduate and graduate students in science and engineering.** Undergraduate and graduate students at the University of Georgia were reached by including outcomes from the MINDS project in various courses, including Environmental Physiology (HORT 4440/6440), Environmental Issues in Horticulture (HORT 4990/6990), Greenhouse management (HORT 4050/6050), Nursery Management (HORT 3630), and 'Measurement and Control in Plant and Soil Science' (HORT 8160). Students were exposed to this project either by incorporating outcomes into lectures (all the above courses) and by given students hands-on experience in building and using soil moisture sensor-based irrigation controllers (HORT 4440/6440 and 8160).

**The scientific community** was reached through presentation at scientific meetings (including the 2014 Annual Conference of the American Society for Horticultural Science, Orlando, FL and the 2014 Meeting of USDA regional project NCERA-101 'Controlled Environment Technology and Use') and scientific publications (in HortScience and Acta Horticulturae)



#### 4. University of Maryland

We continued our implementation of sensor-based irrigation control with all our commercial partners in year 5. This included both set-point (Local) control strategies at Flowers by Bauers, Hale and Hines and Moon Nurseries and at Waverly Farm. We continued testing Global control strategies for irrigation control of mixed blocks at Raemelton Farm.

We also focused on using the information provided by sensor networks to implement smart irrigation decisions from small areas (using indicator species) to larger blocks, and monitoring those larger blocks to minimize risk. We illustrate these approaches in the more detail for each operation (below).

Working with the economic team, we also focused on translating savings in water, labor and other inputs into dollar values, to gauge returns on investment.

Many of these results were published as open access articles in a HortTechnology special series (Fig. 23) which can be downloaded from

<http://horttech.ashspublications.org/content/23/6.toc>

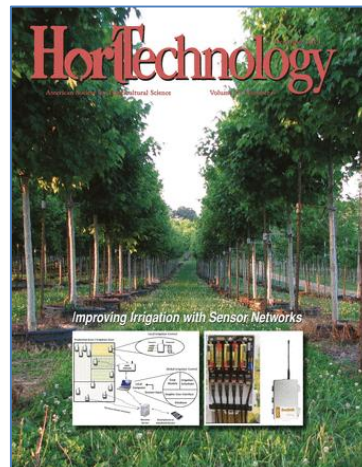

Fig. 23. HortTechnology Special Series

#### Summary of Results from Commercial Nursery and Greenhouse Operations

##### 4.1 Bauers Greenhouse: Cut-flower Snapdragon Production

In March, 2013, we initiated scale-up studies with the objective of characterizing and understanding the variability that exists in the tray system snapdragon production that Flowers by Bauers had implemented (See Year 4 report).

Thirty-two plants (8 plants in 4 rows) are planted in each tray (1'x 2' x 4" deep), on either side of two irrigation tubes that run on top of each tray (Fig. 24).

We scaled up to two production beds with 4 independently controlled irrigation zones (Fig 25). Each production zone had a total of 216 trays for a total of 6912 plants per zone.

The production beds were planted with *Antirrhinum majus* L.) cv. Potomac Early White



Fig. 24. Single Tray, showing plant and drip tap placement at Bauers greenhouse

Continuous irrigation decisions between 6am and 6pm were made by one nR5-DC per zone connected to a latching solenoid for each zone. An additional EM50R node was also used to assess sensor variability within different trays (across the bed). Average substrate volumetric readings were taken every minute and averaged over a 15-minute period from eight EC-5 sensors. These readings were used to calculate a running average for the irrigation decision, using the global control function of Sensorweb. Badger flow meters (Badger Meters, Inc., Milwaukee, WI) were utilized to measure irrigation volumes to each of the 4 irrigation zones, and for fault detection (using the alert feature in Sensorweb).

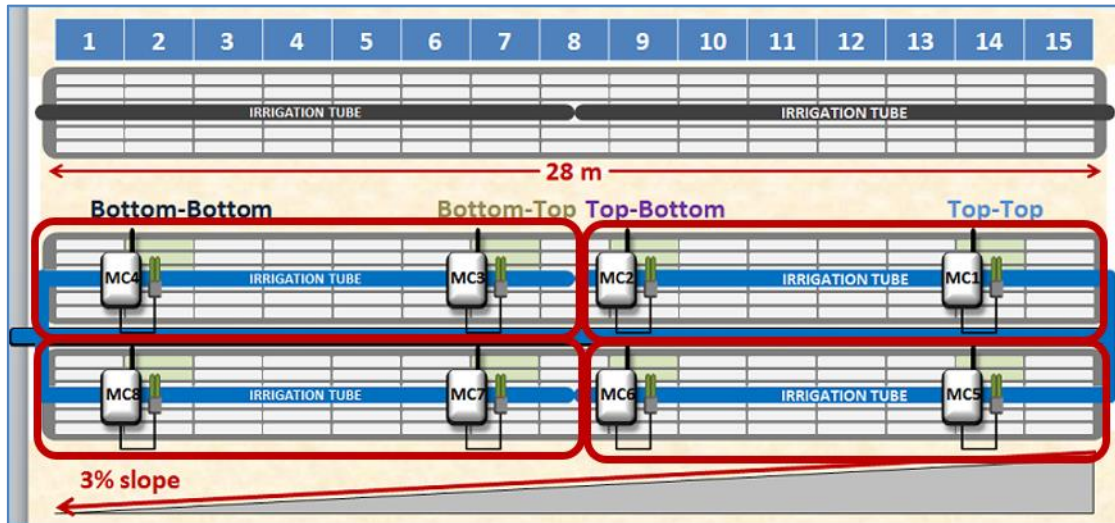

**Fig. 25. Graphic illustrating the four independent irrigation zones (outlined in red) under nR5-controlled irrigation scheduling, in two production beds at Flowers by Bauers greenhouse .**

**The objectives of this scaling-up were to:**

- Ensure that set-point control irrigation is an effective strategy for the commercial production of Snapdragon in this tray system (i.e. ensure yields are equivalent or better than previous crops).
- Determine the variability of substrate VWC in each zone, ultimately to reduce the number of nodes and sensors required for a good irrigation decision in each production bed.
- To understand if the reduced substrate volume in the trays affected irrigation frequency and timing as the crop grew.
- To determine the optimal positioning of sensors within individual trays

Figure 26 illustrates typical automated irrigation decisions for one of nR5-controlled zones. Set-point control was set at 31% VWC (moisture content). The colored horizontal lines show readings from three EC-5 sensors over the day. Red arrows indicate time and number of irrigations applied during the day, depending on plant water use. The purple line shows accumulated irrigation water applied (flow meter data).

Results from these scaling experiments indicated that the optimal place (driest point) was in the middle of the bench (Bottom-Top position; Fig. 25) due to irrigation system effects. No significant reductions in yield or grade quality were noted for set-point irrigation in two successive crops grown during Fall/Winter (Group 1 / 2) followed by a group 3 crop grown in spring / early summer, 2014.

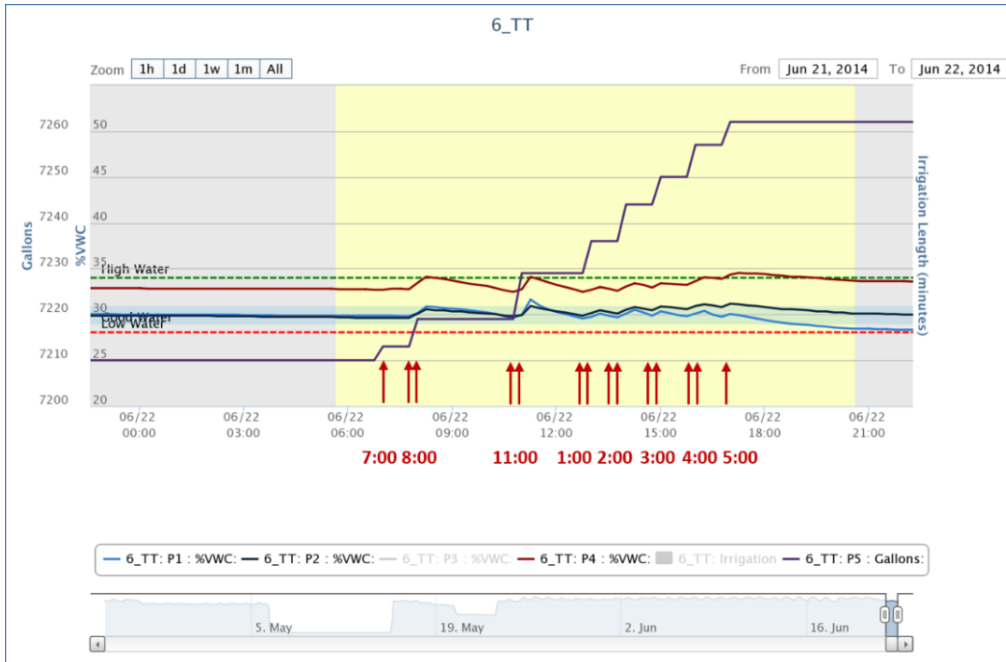

**Fig. 26. Sensorweb graph from illustrating sensor data from one irrigation zone on a typical day. Irrigation events are annotated with red arrows, highlighting time and numbers of cyclic irrigations during each scheduled irrigation window (6 minutes window every hour between 6am and 4pm; Sensorweb scheduling tool not shown).**

**Long-term Economic Study** (Also see the Economic Team report; Pages 54-55)

Six years of data were analyzed by the Economic team from Flowers by Bauers. Production and sales records were used to estimate the effects of wireless sensor networks on the yield and quality of Snapdragon quality (Fig. 27; Table 2). A statistical analysis of these data showed that wireless sensor networks accelerated production time and increased yields. One additional crop was harvested annually, while yields increased from 5% to 80%, depending on cultivar (Lichtenberg et al., Irr.. Science; In review).

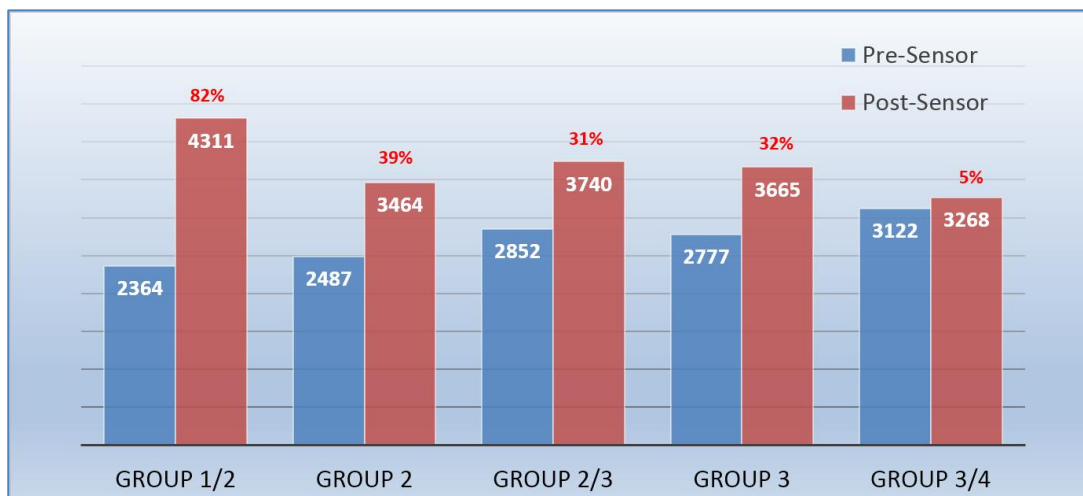

**Fig. 27. Impact of using sensors on total Snapdragon stems produced, by cultivar group (season) for Flowers by Bauers from 2007 – 2009 (pre-sensor) and 2010-2012 (post-sensor).**

Statistical analysis of the combined sales and production data showed that wireless sensor networks increased quality (shares of grade 1 and 2 snapdragons at the expense of grade 3 stems) and thus increased the average price received for most cultivars (data not shown). Increases in yield and grade (quality) resulted in higher profits after sensors were used (Lichtenberg et al., Irr. Science; In review).

**Table 2. Impact of using sensors on annual crop yield, resource and labor costs from 2007 – 2009 (pre-sensor) and 2010-2012 (post-sensor) on total revenue and profit for Flowers by Bauers.**

	Pre-Sensor: (2007 – 2009)	Post-Sensor: (2010 – 2012)		
	2007 -2009	2010- 2012	Difference	Change
Crops/ year	37	38	1	1 %
Stems/ year	106,308	139,382	33,074	31 %
Price/ stem	\$ 0.59	\$ 0.62	\$ 0.03	5 %
Labor costs	\$ 15,905	\$ 17,893	\$ 1,988	12 %
Electricity	\$ 4,109	\$2,923	\$ 1,186	-29 %
Sensor system	\$ 0	\$7,147	\$ 7,147	---
Revenue	\$63,094	\$ 85,679	22,585	36 %
Profit	\$43,080	\$57,716	\$14,636	34 %

#### 4.2 Moon Nursery: Container-Nursery Pathogen Management

Precise irrigation management is not only important in saving water and other resources but also has an overall positive impact on plant health. In container production systems, where the rooting volume is limited, supplying the plants with the right amount of water is critical. Growers and irrigation managers almost always err on the side of caution and typically apply excess water when irrigating container plants. This excess water is lost immediately, leaching nutrients with it, and the container dries out depending how fast water is consumed by the plant and the evaporation rate. In addition to the losses of water and nutrients, the rapid wetting and drying cycles can stress plants and may create a favorable condition for plant pathogens

A study was started in February 2013 at Moon Nursery, MD, which tested the effect of sensor-controlled (nR5 set-point) irrigation in a pathogen management study. Detail of the objectives, treatments and experimental layout were provided in the year 4 report (see <http://smart-farms.net/impacts>).

**The specific objectives of the experiment are to:**

- To test three different irrigation treatments and their impact on pathogen development and survival in two *Rhododendron* species (*R. catawbiense* and *R. chenoides*) grown in 2-gal containers.
- To determine the effect of the irrigation treatments on pathogen survival, as well as plant growth and development.

**Treatments:**

The experiment was laid out in a split plot design and had three irrigation treatments: a wet irrigation treatment (Treatment A), nR5 controlled irrigation treatment where irrigation decisions are based on a 47% substrate moisture content set-point (Treatments B and C), and a wet and dry alternating cycle treatment (Treatment D).

Treatment C included an alternative food waste substrate that had a higher bulk density (reduced aeration) and was irrigated using the same set-point irrigation schedule as in Treatment B (Fig. 28)

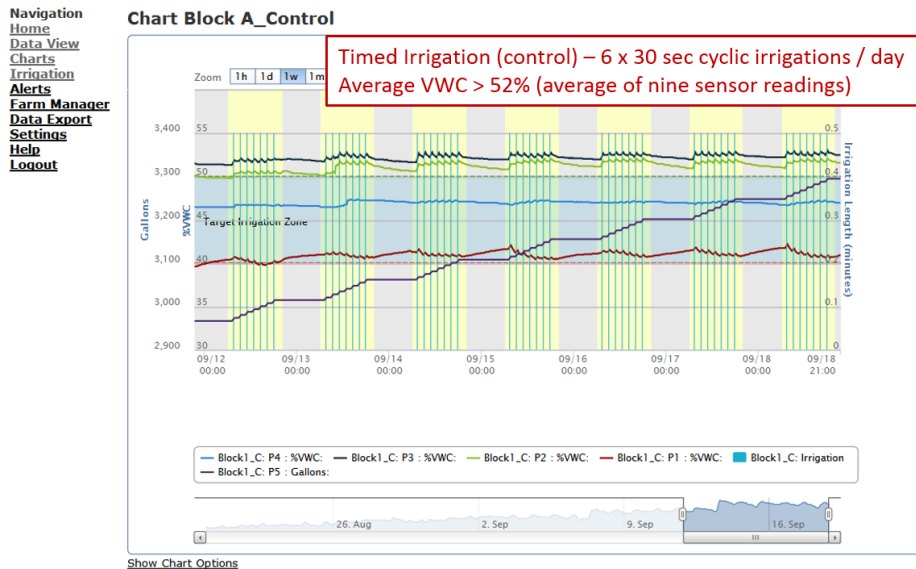

**Fig 28. Irrigation / pathogen management experimental layout at Moon Nursery**

Half of the plants of each species in each treatment were inoculated twice (late June, early September) with *Phytophthora cinnamomi* (see year 4 report).

Irrigation events were scheduled using Sensorweb, using the micro-pulse tool (see Year 4 report for details).

Fig. 29. Illustrates Sensorweb data for the control treatment (A; cyclic, time-based scheduling), set to deliver one 20-sec irrigation pulse, six times a day in summer.



**Fig. 29. Graphical display of substrate moisture (horizontal lines), irrigation frequency and flow meter (water application amounts) for the control treatment (A).**

Figure 30 illustrates irrigation frequencies for the 47% VWC set-point treatment (B).

Weekly irrigation water applications were significantly reduced by irrigation at a 47% VWC set-point (only slightly below container capacity).

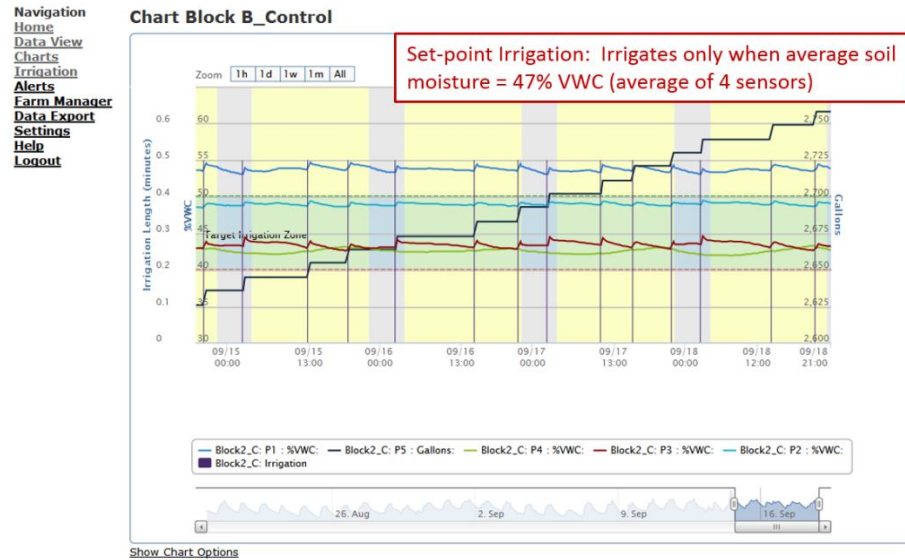

**Fig. 30. Graphical display of substrate moisture, irrigation frequency and flow meter (water volume) for the 47% VWC set-point treatment (B)**

**Results:**

Fig. 31. tabulates irrigation water application totals for each treatment from June to November, 2013.

Treatment C applications in June are highlighted since the food waste substrate required additional irrigation to reduce the total salt (EC) concentration to acceptable levels for plant growth. Note that irrigation volumes decrease significantly after September for set-point controlled treatments.

2013	Treat A (Liters)	Treat B (Liters)	Treat C (Liters)	Treat D (Liters)
June	2,918	2,418	4,212	1,810
July	3,286	2,499	2,023	2,166
August	3,491	2,027	1,000	1,174
September	4,925	3,429	3,081	1,298
October	3,933	1,228	655	1,104
November	2,341	539	519	151
<b>Total</b>	<b>20,894</b>	<b>12,140</b>	<b>11,489</b>	<b>7,704</b>
<b>Reduction in Water Use</b>	<b>---</b>	<b>58.1%</b>	<b>55.0%</b>	<b>36.9%</b>

**Fig. 31. Water use, by treatment from June – November 2013**

Substrate cultures from November 2013 showed that some *P. cinnamomi* inoculum was present in many inoculated sample pots; however only one infected plant was isolated from the November harvest plants (n=48).

Table 3 shows new leaf area data from plants harvested in November. New leaf area is a sensitive indicator of water stress. Although the comparisons between treatments were non-significant, most likely due to low numbers of replicate plants harvested (n=3), the data indicated that new leaf area was larger in the set-point treatment compared to all other treatments. Inoculated plant leaf areas were lower, especially for *R. catawbiense*, for all treatments.

Both species did not grow well in the food waste substrate most likely due to the lower air-filled porosity of this media. It appears that the growth rates of both species were affected by pathogen inoculation long before visible *Phytophthora* symptoms are expressed.

**Table 3. New leaf area for each treatment in November 2013.**

New Leaf Area (cm <sup>2</sup> )	Irrigation / Substrate Treatment			
	A	B	C	D
<b>Non- Inoculated</b>				
<i>R. chionoides</i>	356.6	593.0	307.3	380.4
<i>R. catawbiense</i>	347.9	558.8	204.2	372.4
<b>Inoculated</b>				
<i>R. chionoides</i>	263.7	412.7	0.0	278.6
<i>R. catawbiense</i>	262.5	290.1	124.4	182.9

Due to the hard winter in 2013/14, many plants in this experiment were killed or severely damaged, as the house was not covered. The experiment was therefore terminated and has been repeated in 2014 with new plants, with the exception of the food waster substrate. A lower set-point treatment (VWC = 35%) was included in the 2014 study. Inoculations of half of the plants were done in June, July and August, 2014. Preliminary plant harvest and water use data from this repeat experiment are currently being analyzed.

#### 4.3 Hale and Hines Nursery: Pot-in-Pot Nursery Production

In 2013, we installed a sensor control block at Hale and Hines nursery in March 2013, to enable us to help gain further insight into the varying water use of their diverse inventory of tree species. (Fig. 32).

This control block consists of 4 rows of 15-gal containers and four rows of 30-gal containers, each with 10 trees per row (80 trees in total).



**Fig. 32. Sensor control block at Hale and Hines nursery.**

A complete description of the control block layout was provided in the year 4 report. Figure 33 shows detail of the layout, flow meters and solenoids at the head of each row of ten trees in the block.

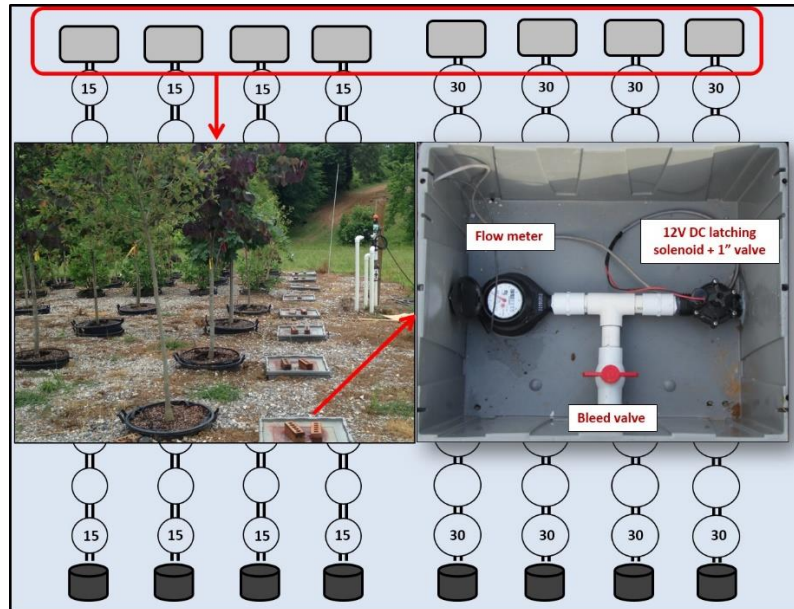

**Fig. 33. Sensor control block at Hale and Hines nursery showing detail of flow meter and latching solenoids connected to the nR5 control nodes. Underlying graphic shows 15 Gal and 30 Gal arrangement of rows (n=10 trees per row)**

Species studied during year 4 included *Betula nigra* (River Birch) and *Lagerstroemia indica* (Crepe Myrtle) in 15-gal containers; *Quercus rubra* (Red Oak) and *Carpinus caroliniana* (Hornbeam). These species were specifically chosen by Terry Hines, as indicator species for different Irrigation Functional Groups (Water Use Class; Table 4). Dogwood and Red Maple comparisons were continued in previously described blocks (see Year 3 and 4 reports). Note that water use classes do not match irrigation volumes applied either by Terry Hines (monitored blocks) nor those applied during the year by sensor-controlled blocks.

**Table 4. Total water use and percent water saved for 6 tree species measured between monitoring vs. control treatments in 2013.**

Water Use Class	Tree Species	Monitoring (gal) *	Control (gal) *	Water Savings (%)
Low	Dogwood	12,257	5,315	56.6
	Crepe Myrtle	2,798	818	70.8
Medium	Hornbeam	9,164	4,661	49.1
	Red Oak	6,538	3,595	45.0
High	River Birch	4,573	3,802	16.9
	Maple	14,626	13,122	10.3



In year 5 (March 2014), the control block was reconfigured to accommodate 8 indicator species. All eight rows were used for sensor-based (nR5-node) control. The data from this block was then used to inform irrigation scheduling decisions for those species in production blocks in the entire nursery (Fig. 34).

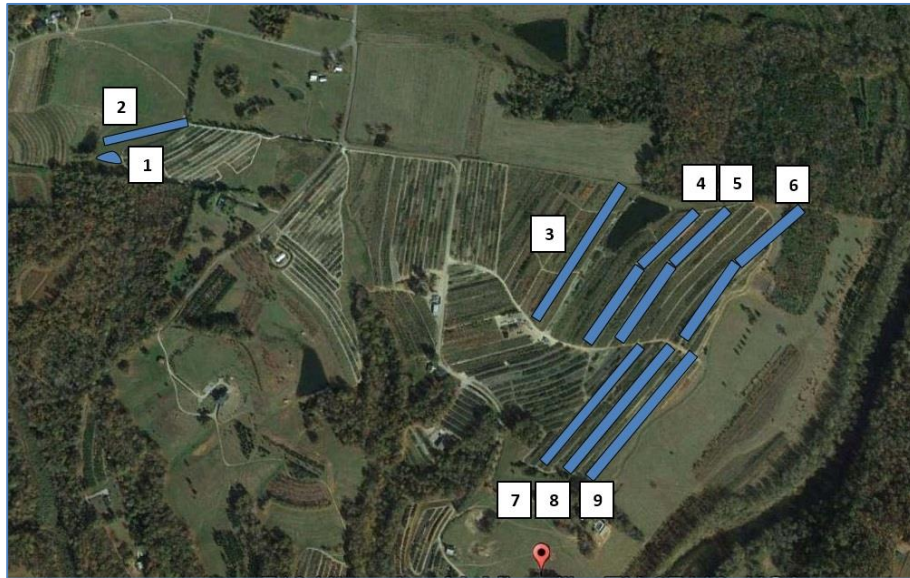

**Fig 34. Production blocks under sensor-based control at Hale and Hines nursery in year 5 (totaling 38.4 acres). Block 1 = Intensively sensed control block; Blocks 2-9 were monitored with a single node at the end of a lateral (one flow meter plus 4 10-HS sensors)**

Figure 35 illustrates the strategic plan for integrating the control block strategy with the existing TUCOR irrigation system at Hale and Hines. Sensorweb will act as an interface between the Decagon control nodes. Discussions between TUCOR and Mayim, LLC have already taken place, and plans are in place to complete this integration in the near future.

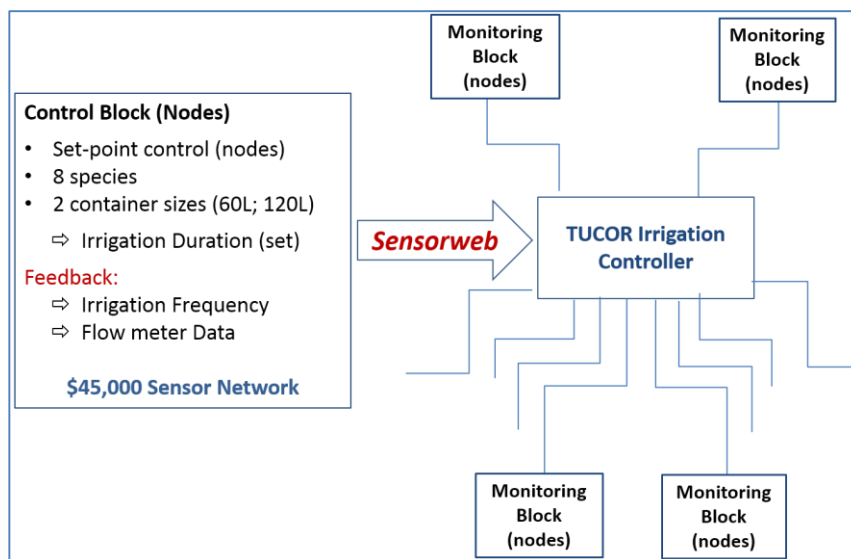

**Fig. 35. Strategic plan for integrating the control block with the TUCOR irrigation control system already in place at Hale and Hines.**

### Economic benefits and return on investment

Data on water use and irrigation management costs with and without a sensor network were used to estimate profitability in the Hale and Hines pot-in-pot container tree nursery (Belayneh et al. 2013). The sensor network reduced both irrigation water application and irrigation management time by at least half. Even though water costs consist only of the cost of pumping water from a nearby river, investment in the wireless sensor network yielded a relatively high rate of return.

A price sensitivity analysis (Table 5) indicated that sensor networks would be even more profitable in areas where water is scarce and costly (e.g., California), reducing a 2.7 year payback period to less than 4 months, based on the total cost of the network (\$45,000) amortized over three years. Annual net savings from this network based on \$3 per 1000 gal if water was estimated to be over \$138,000 (Belayneh et al. 2013).

**Table 5. Cost and benefits of the sensor network at Hale and Hines (from Belayneh et al., 2013).**

Costs and benefits	Water price [per 1000 gal (3.785 m <sup>3</sup> )] <sup>z</sup>			
	\$0.17	\$1.00	\$2.00	\$3.00
Benefits	2.7 year ROI		4-month ROI	
Pumping cost savings	\$ 8,137	\$46,944	\$94,189	\$141,283
Management cost savings	\$12,150	\$12,150	\$12,150	\$12,150
Annual savings	\$ 20,288	\$59,094	\$106,339	\$153,433
Costs				
Annualized sensor system cost	\$14,205	\$14,205	\$14,025	\$14,025
Annual maintenance	\$ 1,000	\$1,000	\$1,000	\$ 1,000
Total sensor system cost	\$15,205	\$15,205	\$15,025	\$15,025
Annual net savings	\$ 5,263	\$44,069	\$91,313	\$138,408

<sup>z</sup>Corresponding water prices = \$55, \$326, \$652, and \$978 per acre-foot; \$1/acre foot = \$8.1071/hectare-meter.

#### 4.4 Raemelton Farm: Field Tree Production

During years 3 through 5, we installed nR5-DC nodes in soil (field) environments to test Sensorweb functionality and conduct monitoring (grower-scheduled) vs. sensor-controlled irrigation in various production blocks. This included a 1-year-old transplant (Red Maple) block, and 3-year-old maple and dogwood blocks. During these years, we quantifies water use and tree growth (trunk diameter) over time (Figs. 36, 37 and 38, below).

In year 4 and continuing in year 5, we scaled up from controlling single rows to entire (mixed) blocks with 35-45 rows of trees per block. We implemented global set-point control on these blocks by monitoring at least 3 species with EM50R nodes, controlling irrigation schedules according to the water needs of the highest priority (most profitable) species – in this case *Ginko biloba*. A single nR5-DC node controlled an existing 2-inch irrigation valve with a latching solenoid. Water applications were monitored with 1" badger flow meters on each monitored row (with and EM50R and four 10-HS sensors at 6" depth in four trees in the row).

Fig. 36 shows mean trunk diameters for *Acer rubrum* trees from transplanting in May 2012 through Sept., 2014, comparing sensor-based control (Maple Control) vs. grower-scheduled (Maple Monitoring) irrigation. The trunk diameters of sensor-based irrigation trees were significantly larger from year 2 onwards.

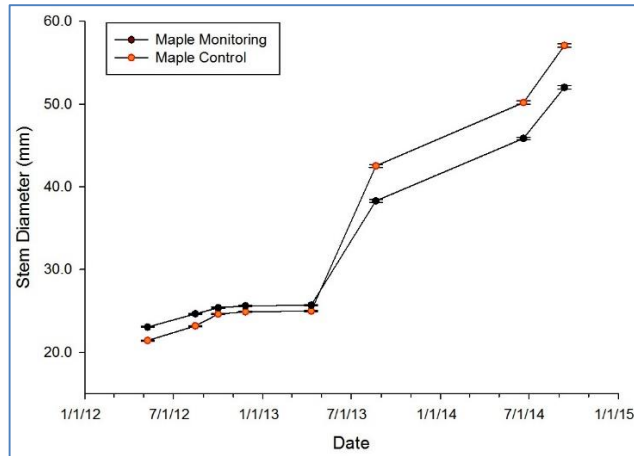

**Fig. 36. Mean trunk diameter (n=29) of 1-3 year-old *Acer rubrum* trees from May 2012 through Sept. 2014. Standard errors shown as horizontal bars**

When sensor-controlled irrigation was imposed later in production (years 3-5), differences were not significant (Fig. 37), presumably because root systems were able to exploit rainfall as well as irrigation. Nevertheless, irrigation volumes applied to the control row of trees were on average 40% less than applied by the grower.

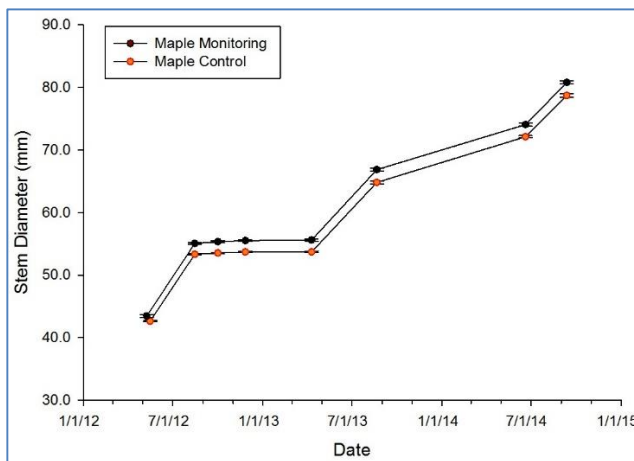

**Fig. 37. Mean trunk diameter (n=28) of 3-5 year-old *Acer rubrum* trees from May 2012 through Sept. 2014. Standard errors shown as horizontal bars**

In the case of Dogwood however, sensor-controlled irrigation did show a small increase in trunk diameter for mature (3-5 year-old) trees in year 2 (Fig. 38, at right).

In all cases, sensor-based irrigation control showed no reduction in tree caliper, while considerably reducing water applications.

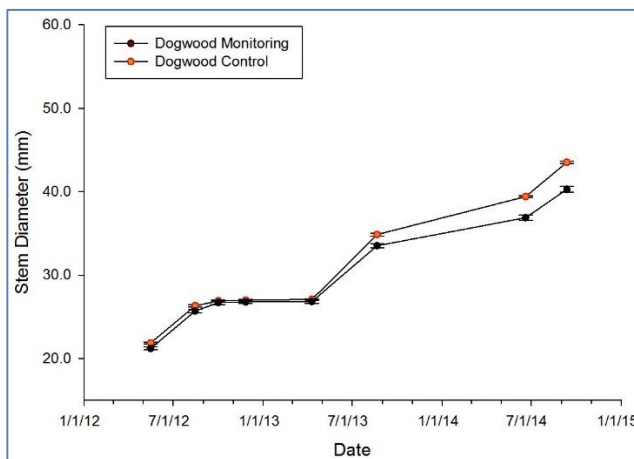

**Fig. 38. Mean trunk diameter (n=34) of 3-5 year-old *Cornus florida* trees from May 2012 through Sept. 2014. Standard errors shown as horizontal bars**

#### 4.5 Waverley Farm: Field Shrub and Tree Production

In year 5, we continued the study initiated in 2013 (see Year 4 report), comparing nR5-controlled sensor irrigation compared to grower-controlled irrigations with one slow-growing tree species – dogwood (*Cornus florida*) and one fast-growing shrub species – lilac (*Syringa prestoniae*). One row of plants from both species was irrigated by nR5-DC nodes based on volumetric soil moisture readings from four 10HS sensors inserted into the root ball of four individual trees. A second row of trees from each species was irrigated by the grower following the normal irrigation practice followed in the nursery. Irrigation water applications to each row were measured with badger flow meters. Regular growth measurements were made on all trees in each row in order to see growth differences arising due to the irrigation systems.



Fig. 39 (at left) shows the lilac block one year after planting. The left row of plants was irrigated by the grower drip-irrigating the plants for a 24-hr event weekly in the absence of a good rain, equivalent to about one acre inch. The row on the right was irrigated automatically based on a 25% soil moisture volumetric water content, whenever necessary.



Fig 40a. Box with flow meter at head of grower-scheduled row.



Fig 40b. Box with flow meter and solenoid at head of sensor-scheduled row.

Fig. 40a, b. Each row of plants above has a flow meter as seen within the boxes. The right hand (sensor-controlled irrigation) row (Fig. 40b) also has a solenoid valve that is opened and closed by the nR5 node located half way up the row.

The grower's irrigation schedule applied 10,800 gallons of water from May 2013 through Sept. 2014, whereas the sensor-controlled irrigation applied 3,050 gallons, a reduction of 72% water applied to this block of lilac, with a significant increase in canopy volume (quality). The control block row is expected to be saleable by spring, 2015 at least six months ahead of the grower-scheduled irrigated row.

Waverley nursery installed flow meters on all pumps in 2011. Previous estimates of water use for the farm were 24,000,000 gallon per year. From adjustments to irrigation based on sensor-based irrigation, total

water use was 12,000,000 gallons in 2012 and 9,000,000 gallons in 2013. Further increases in efficiency are expected from the 40 acres (20% of total acreage) of newly transplanted blocks in 2013 and 2014. Jerry Faulring (the owner) estimates that he will be able to double the life expectancy of his pumps from an average of 7-8 years to possibly 14 years, a reduction in electricity consumption, maintenance and reduced labor.

#### 4.6 Scaling up Green Roof Research

Green roofs are typically designed according to civil engineering standards, determined by curve numbers for predicting storm water runoff from a specific rainfall event, in inches per hour (Maryland Department of Environment, 2009). However, these runoff estimates are known to be inaccurate for green roofs, since they fail to take into account the many site-specific variables that determine green roof efficiency, as a combination of physical (aggregate layer depth, organic matter content) and biological components (e.g. plant type, coverage, age and health). Data have been collected over the past 10-15 years of runoff from various green roof installations throughout the US (and world), but estimates of efficiency still vary widely, since runoff is dependent on specific roof designs as well as antecedent moisture conditions on the roof.

Starry (2013) developed a relatively simple water-balance model (Fig. 41) that gathers the data from wireless sensor networks to predict stormwater runoff from roofs with varying design elements (SCRI-MINDS year 4 report). This model integrates daily environmental conditions with substrate moisture content and crop coefficient ( $K_c$ ), that uses the FAO56 Penman-monteith ET model to predict stormwater runoff from green roofs. This model was verified by using small-scale platform data as part of her PhD thesis (Starry, 2013; Fig. 42).

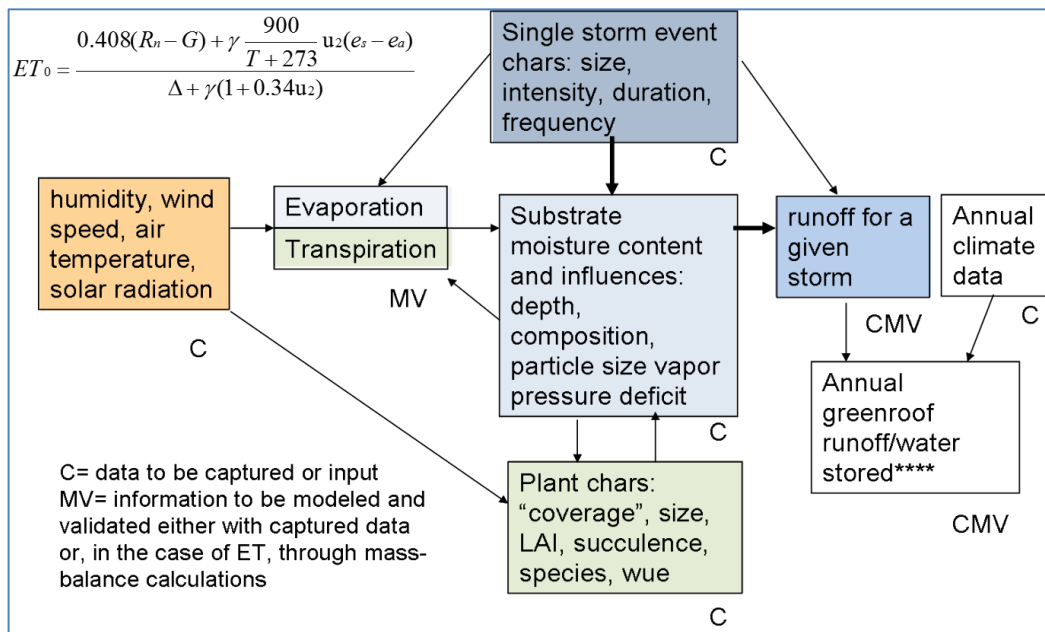

**Fig. 41. A green roof water balance model, integrating daily environmental conditions from an on-site weather station, substrate moisture content and crop coefficient data, that uses the FAO56 Penman-monteith ET model to predict stormwater runoff from green roofs ( from Starry, 2013).**

We now have a relatively robust and cost-effective means to monitor the performance of green roofs using wireless sensor systems, to quantify the efficiency of those green roofs to building managers and municipalities over weeks, months or years.

These monitoring capabilities and model predictions will help improve our understanding of the underlying mechanisms that are responsible for green roof storm water retention efficiency.

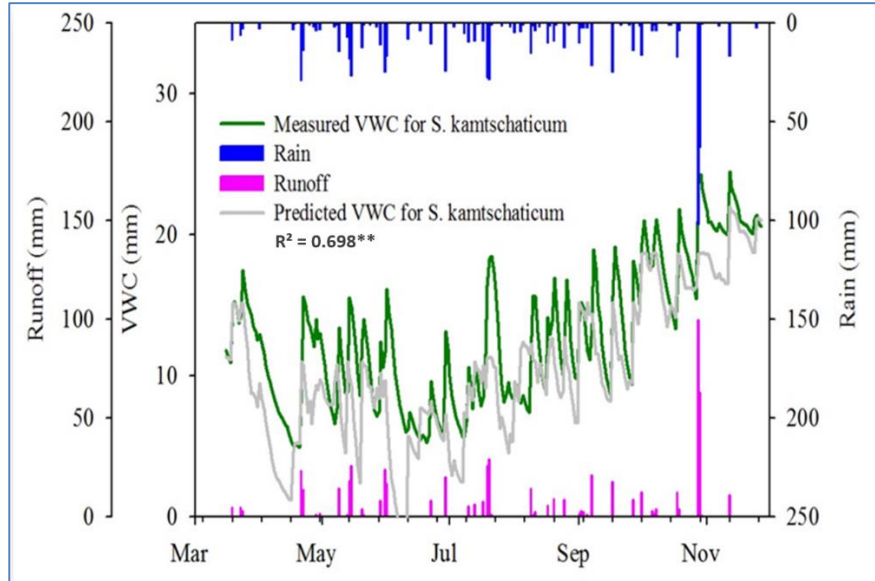

**Fig 42. Verification of Starry (2013) green roof water balance model, illustrating predicted vs. actual runoff data from four 1m2 small-scale platforms planted with *Sedum kamschaticum* in 2012.**

As part of our scaling activities in year 5, we had the opportunity to partner with a National Renewable energy project at NASA-Johnson Space Center in Houston, TX., where a five-node EM50G sensor network was installed (Figs. 41 and 42) to inform building managers of (a) the average substrate moisture status (for manual irrigation management), as well as to provide some preliminary data for stormwater runoff prediction. Fig. 41. Illustrates how data from the EM50G nodes is transmitted via a 3G cellular modem in each node to a cloud server, located in Washington State.

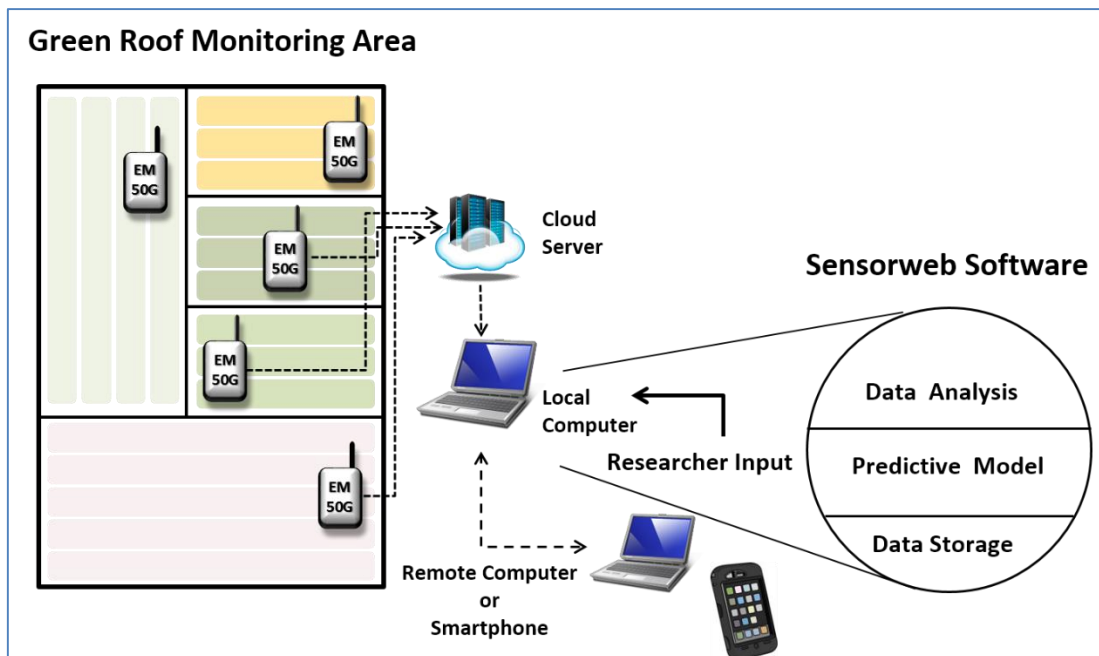

**Fig. 41. Graphic of the green roof EM50G monitoring network installed on Building 12 at NASA-Johnson Space Center in Houston, TX**

The EM50G network on Building 12 at NASA-Johnson Space center consists of one node that collects environmental data (total radiation, PAR radiation, rainfall, wind speed and direction; Air temperature, relative humidity and vapor pressure deficit) on a five-minute basis. Four other nodes collect substrate moisture and temperature data every 15 minutes from Eco-TM sensors in the grid pattern as shown in the insert (Fig. 42).

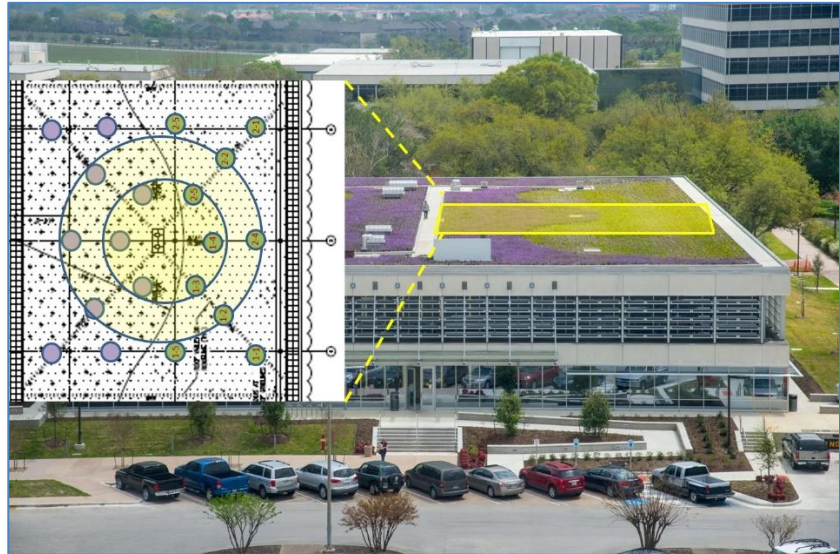
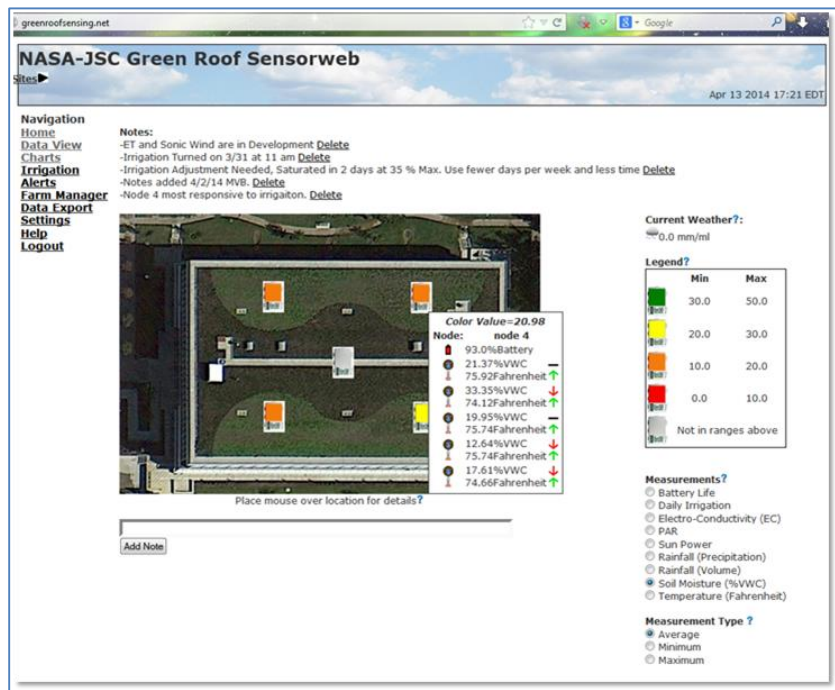

**Fig. 42. Schematic of the green roof showing the EM50G sensor positions on Building 12 at NASA-Johnson Space Center in Houston, TX**

The 5- and 15-minute data from the EM50G nodes is transmitted to the cloud server every 6 hours to the cloud server in WA. From there, the data is downloaded into Sensorweb on a computer in College Park, MD.

The data is then readily available for analysis from the dedicated project website at (<http://greenroofsensing.net>) to anyone who has password privileges.

We can therefore now cost-effectively provide remote data collection services from remote green roofs anywhere in the world that has 3G network access.



**Fig. 43. Sensorweb homepage for the EM50G sensor network NASA-Johnson Space Center in Houston, TX**



**Fig 44. A Sensorweb screenshot of data from an EM50G node, showing rainfall and soil moisture dynamics**

Fig. 44 illustrates the type of data that can be collected from these green roof networks. Fig 44. Shows soil volumetric water content (horizontal colored lines), together with rainfall (vertical blue bars). Increases in soil moisture without rainfall are due to daily irrigation events.

An immediate outcome of the monitoring of this green roof was a reduction in daily irrigation frequency from 1-2 times per day to once every other day on average. This also improved the overall health of the sedum green roof.

Green roofs are being installed in urban areas for a variety of reasons – but one of the primary reasons is that they have a demonstrated record of reducing stormwater runoff from impervious (hard) surfaces and are used to mitigate stormwater runoff (see below). The District of Columbia Water and Sewer Authority bills residential, commercial and government customers on a monthly basis. The DC Water Authority charges for water, sewer, customer metering and impervious area (see CRIAC fees, below). Water and sewer charges are billed volumetrically, that is, they are based on how much water a household or business consumes (<http://www.dewater.com/customer-care/rates.cfm#current-rates>).

The Clean Rivers Impervious Area Charge (CRIAC) is a sewer fee that takes into account the area on a property that is made of impermeable surface, which contributes to runoff and combined sewer overflows.

The CRIAC generates funds to cover the cost of the [Clean Rivers Project](http://www.dewater.com/cleanrivers) (also referred to as the [Combined Sewer Overflow Long Term Control Plan](http://www.dewater.com/cleanrivers), a \$2.6 billion capital project mandated by the federal government.

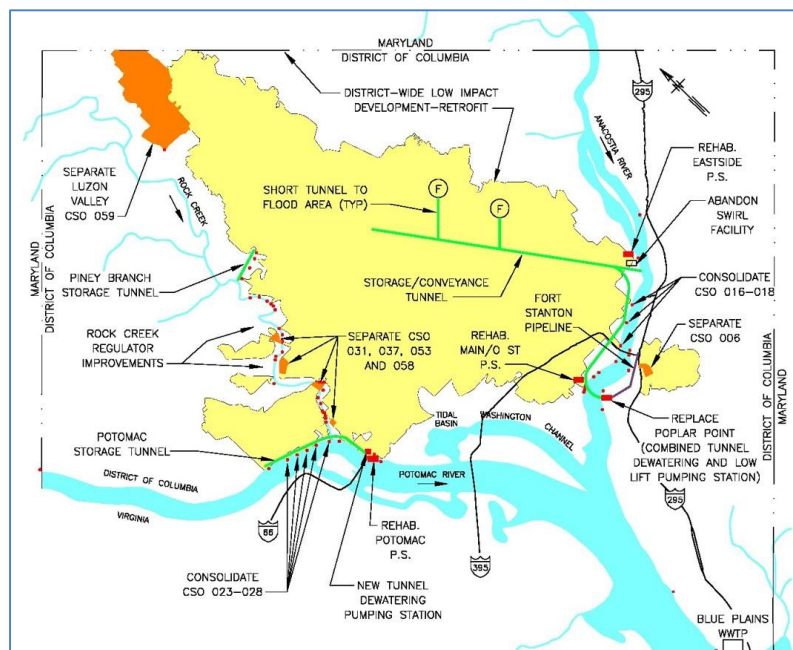

**Fig 46. Washington DC Combined Sewer Outlet District (<http://www.dewater.com/cleanrivers>)**



In year 5, we also partnered with Furbish Company (Baltimore, MD) to install an EM50G sensor network to monitor a private green roof on [Potomac Plaza Apartment complex](#) in Foggy Bottom, Washington, DC. By monitoring the performance of this green roof, Furbish is not only using the data to schedule maintenance (manual irrigation events) but also wishes to calculate the long-term stormwater reduction efficiency of this green roof, to understand how this could benefit their applications for rebates and other CSO stormwater reduction incentives.



**Fig 47. Green roof sensor network installed at Potomac Plaza, Washington, DC.**

#### 4.7 Estimating Crop Water Use in the Dulcepamba watershed in Ecuador

In Fall, 2013 we were approached by a Fulbright Scholar, Ms. Rachel Conrad based in Ecuador to assist her with a project in the Dulcepamba watershed in southern Ecuador. A multinational company, Hidrotambo S.A., has acquired a 50-year concession for 90% of the flow from most of the rivers in this watershed for the next 50 years, for a 8MW hydroelectric project situated at the base of this watershed (Fig 48). Farmers have already been prevented from diverting water for daily use, for their livestock, and for irrigation of crops, posing a threat to their livelihood from farming many water-dependent (high-value) crops.

Rachel Conrad is working with the farming communities in this watershed. In order to convince Government authorities to return water rights to local farmers, their water needs must be quantified, both in terms of supply (from rainfall) as well as demand (by crops, based on acreage and irrigation need). With this in mind Rachel Conrad's project aims to quantify the current total volume of available water in the Dulcepamba watershed, and the amount of water required for irrigation of crops in excess of normal rainfall. With verified data for their water needs, farmers might be able to re-establish their water rights through concession from the Ecuadorian government.

**Fig. 48. Location of the Dulcepamba watershed in south central Ecuador.**

The topographic image shows the river valleys in the watershed. The Hidrotambo hydro-electric project is situated at the base of this watershed.

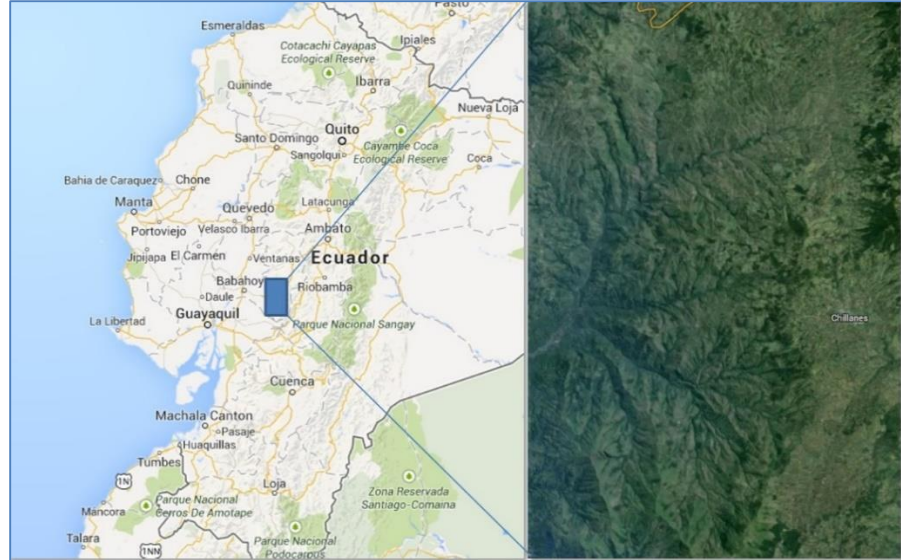

An interdisciplinary team of faculty and students was formed in Fall, 2013 and through a Seed grant from the [Future for information Alliance](#) at the University of Maryland, travelled to Ecuador in January, 2014 to assess the water needs of the 72 farming communities in the watershed

Four EM50G weather stations were strategically installed in four geographically distinct regions of the watershed, based on community input and support (Fig.49). These weather stations are instrumental in gathering local environmental data, to estimate the daily water use of crops using the FAO 56 Penman-monteith equation in microclimates across this watershed. Similar to the methodology described in the green roof section, 15-minute average environmental data from these EM50G nodes (Fig. 50; using local provider SIM cards) was streamed to the cloud server every six hours, and downloaded by a local computer running Sensorweb in College Park, MD.

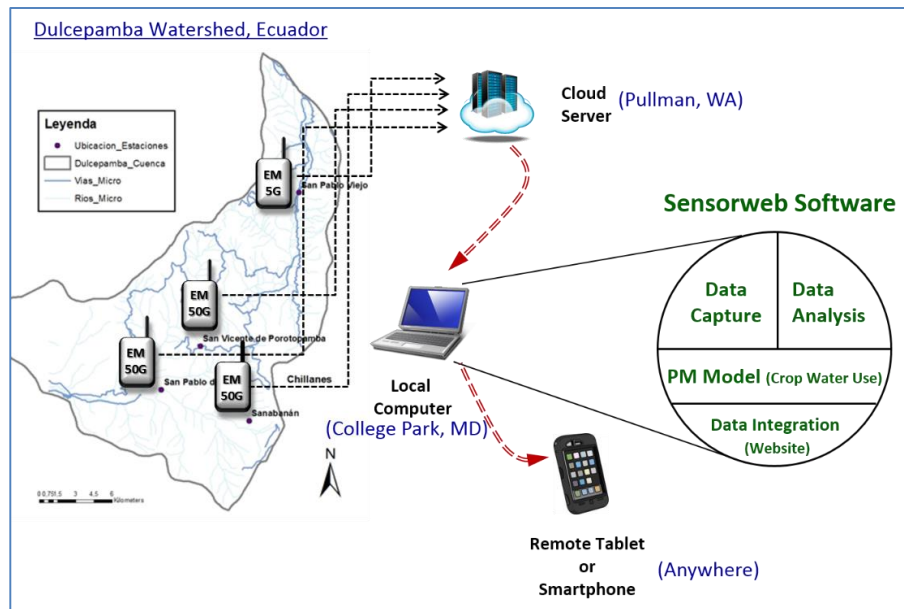

**Fig. 49. Graphic illustrating the approximate locations of the four EM50G weather stations in the Dulcepamba watershed and how data are streamed via #G cellular networks to the cloud and downloaded into Sensorweb on a computer in College Park, MD.**

**Fig. 50.** An EM50G weather node installed in the Dulcepamba watershed, illustrating the environmental sensors attached to the node.

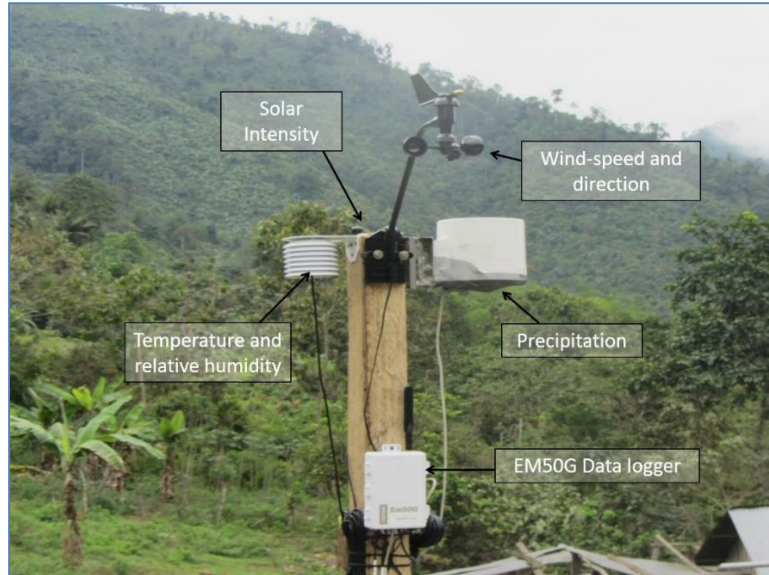

**The specific objectives of this work were to:**

- Determine daily water needs of major crops in the watershed based on real-time weather data using internationally accepted crop modeling methods for computing crop water requirements
- Determine the total acreage of major crops in the watershed through the creation and analysis of land use and major irrigated crop maps (by creation of a GIS database)
- Integrate information from crop type maps with crop water use models in order to estimate the total amount of water required to grow crops in the watershed.
- Disseminate weekly crop water use, rainfall/precipitation and required irrigation data to residents of the watershed through an easy-to-understand website.
- Inform the community members of their constitutional rights concerning irrigation water concessions.

During a follow-up capstone class during spring, 2014, the University of Maryland team then integrated GIS crop maps with crop water use models to estimate crop water demand of the entire watershed. The crop water use models were integrated into Sensorweb, to inform a summary website (Fig. 51) that was developed to communicate the crop water use and irrigation needs of crops back to the community (Figs. 52; 53).

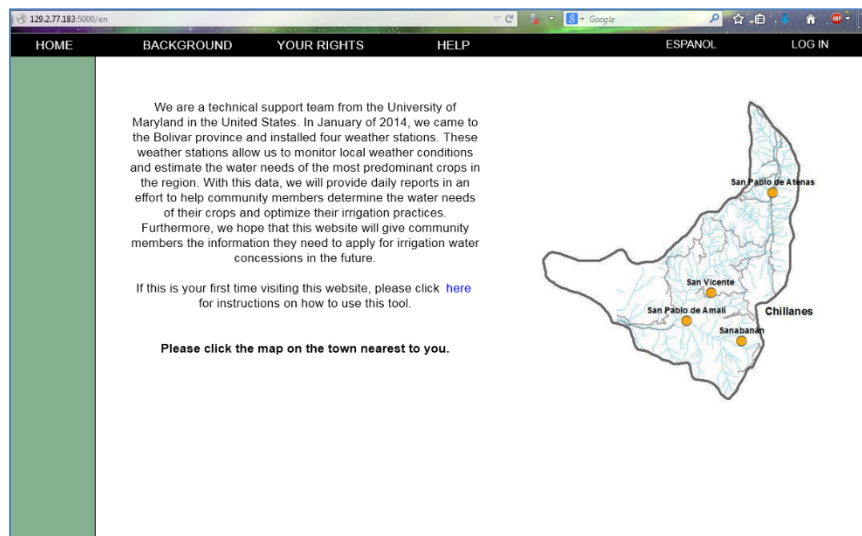

**Fig. 51.** The bilingual community website (<http://dulcepambaagua.net>) illustrating the propose of the website, the locations of the weather stations and access to the summary data.

The <http://dulcepambaagua.net> website is built to disseminate weekly crop water use, precipitation and irrigation needs to residents of the watershed (Fig. 52). More importantly, the data from each of the crops from each specific region will be aggregated over the year to provide total water use for the entire watershed, based on the total irrigated crop acreage.

**Fig. 52. Explanation of the water use tables on the website**

**Como usar esta herramienta**

- Aquí son tablas de datos para cada semana del año. Cada tabla incluye una semana de datos con la excepción de la semana actual, que puede tener menos que siete días de información. Cada semana comienza el lunes y termina el domingo.
- Aquí es la cantidad total de lluvia durante la semana, en milímetros.
- Esta columna representa la cantidad total de agua, en litros, que Ud. necesita proveer a cada metro cuadrado del cultivo cada semana. Generamos la estimación con los datos del clima local de cada semana.
- Esta columna muestra la cantidad total de agua (en litros) que se necesita aplicar a cada metro cuadrado de su cultivo para satisfacer su necesidad semanal de agua. Si el número está en ROJO, no hubo suficiente lluvia durante la semana en cuestión, así que Ud. necesita regar su cultivo con la cantidad de agua que está escrito en ROJO (en litros por metro cuadrado). Si el número está en VERDE, si hubo suficiente lluvia durante la semana, por lo tanto riego no es necesario, y el número en VERDE representa la cantidad de exceso de agua que el cultivo recibió durante la semana en cuestión.

Con esta información, Ud. puede tomar en consideración si aplicó demasiada agua de riego, suficiente agua de riego, o menos que suficiente agua de riego, cada semana. De esa manera, Ud. puede mejorar su habilidad de predecir las necesidades de agua para sus cultivos y así regar en una manera más eficiente.

Cultivo	Uso de Agua (mm)	Necesidad de Riego (L / m <sup>2</sup> )
Banana	3 15.95	4 131.5
Barley	15.24	124.4
Bean	15.24	124.4
Blackberry	14.0	112.0
Maize	15.95	131.5
Potato	15.24	124.4
Tomato	15.24	124.4
Wheat	15.24	124.4

Precipitation Total: 2.8mm.

**Fig. 53. Crop water use tables for the Sanabanan region on the website for the week 3 - 9 Nov, 2014.**

Green numbers indicate water in excess of crop water needs. Red numbers from the previous week indicate the irrigation water needed for each crop (in Liters / m<sup>2</sup>)

**Sanabanan**

LA SEMANA ANTERIOR

Cultivo	Uso de Agua (mm)	Necesidad de Riego (L / m <sup>2</sup> )
Banana	3.13	5.3
Barley	2.99	3.9
Bean	2.99	3.9
Blackberry	2.74	1.4
Maize	3.13	5.3
Potato	2.99	3.9
Tomato	2.99	3.9
Wheat	2.99	3.9

Precipitation Total: 2.6mm.

Cultivo	Uso de Agua (mm)	Necesidad de Riego (L / m <sup>2</sup> )
Banana	0	26.0
Barley	0	26.0
Bean	0	26.0
Blackberry	0	26.0
Maize	0	26.0
Potato	0	26.0
Tomato	0	26.0
Wheat	0	26.0

Precipitation Total: 2.6mm.

Continuing project objectives are to provide baseline data for future analysis of the economic impact of the hydroelectric project on crop production; determine average volumetric flow rates of major tributaries in the Dulcepamba watershed during both the wet and dry seasons and estimate the total volume of surface water available in the watershed throughout the year by utilizing the United States Geological Survey's mechanical current-meter method.

With a better understanding of irrigation water needs and water availability information, farmers will have the concrete data necessary to collectively apply for water rights in the face of the hydroelectric project's concession.

#### 4.8 People involved at University of Maryland

In addition to four faculty members at UMD (Drs. Lea-Cox, Ristvey, Cohan and Lichtenberg), we have been ably assisted by Mr. Bruk Belayneh (Research Technician) and Ms. Ruth Miller (Administrative / Financial Assistant). Drs. Cohan, Ristvey and Lea-Cox are the leads on the green roof research with Mr. Patrick Beach (IT guru in the Plant Science Department) has provided continuous support on Connect webconferencing, Traction and server maintenance for the project.

There is currently one Postdoctoral Research Associate (Dr. John Majsztrik), two PhD students (Olyssa Starry and Whitney Gaches) and two MS students (Clark de Long and Elizabeth Barton) being supported by this project. John Majsztrik has led the national survey effort and the economic analysis of Flowers by Bauers and Hale and Hines data with the Economic team of Drs. Erik Lichtenburg and Dennis King.

Additionally, three undergraduate students (James Zazanis, Zach Beichler and Ian Reichardt) are student research interns working on the project. Dr. Lea-Cox and Bruk Belayneh support all research at Bauers greenhouse, Hale and Hines nursery, Raemelton and Waverly farms together with assistance from James Zazanis and Zach Beichler. Ian Reichardt developed the web interface for the Ecuador project. Kenneth Hunsley is working on a web-based interface with Sensorweb for green roof applications.

#### 4.9 Dissemination of Results to Communities of Interest

**Growers: Online Knowledge Center.** John Lea-Cox assisted the UGA team to get all project members to contribute learning modules for the project's knowledge Center ([www.smart-farms.org](http://www.smart-farms.org)) and has contributed to the peer review process as senior Editor. The UMD (including the economic) team has developed ten learning modules.

**Growers: Presentations and workshops at trade shows,** including Chesapeake Green (Maryland), Cultivate '14 (Ohio) - the largest greenhouse trade show in North America and The Seeley Summit in Chicago, IL.

**Training of undergraduate and graduate students in science and engineering.** Twenty-one undergraduate students at the University of Maryland were reached by including sensor-based experiential projects in HORT432: Greenhouse Management, taught during spring 2014 by Dr. Lea-Cox and assisted by James Zazanis.

A group of five interdisciplinary undergraduate students from environmental science and policy, economics, sustainability studies, plant sciences, environmental and international engineering, Spanish, communications, and international development were involved in the Ecuador Dulcepamba watershed Assessment study through two courses led by Dr. Lea-Cox. A brief report can be accessed from the [UM-Division of Research](#). A full team report can be requested by emailing John Lea-Cox.

**The scientific community** was reached through presentation at scientific meetings (including the 2014 Annual Conference of the American Society for Horticultural Science, Orlando, FL and the 2014 Meeting of USDA regional project NCERA-101 'Controlled Environment Technology and Use') and scientific publications in various journals including HortScience and Acta Horticulturae. A number of webinars were also recorded at the ASHS meetings and are publically available through the ASHS website at <http://ashs.org>

## C. Economic and Environmental Benefits - University of Maryland (UM) and UM Center for Environmental Studies (UMCES)

The overall objectives of the SCRI-MINDS project economic team was to quantify the private and public benefits of wireless sensor networks in field, container, and greenhouse ornamental production, and monitoring of green roof systems. Information from sensor networks is valuable when (1) it allows growers to make better decisions and (2) the increase in value from better decisions exceeds the cost of acquiring and processing the information. During year 5 of the project, the economics team was able to demonstrate and quantify the potential profitability, environmental benefits, and adoption rates of wireless sensor networks in a variety of contexts.

### 1. Profitability Analysis of Wireless Sensor Networks:

During year 5 of the project, the economic team finalized methods for estimating potential benefits of sensor networks, including input reductions, growth acceleration (reduced time to harvest), improved plant health, lower disease losses and enhanced appearance. Those methods were then applied in several case studies using a combination of experimental data and operational information from growers involved in the project.

1. ***Gardenia Production in Georgia.*** Data on production practices and costs with and without a sensor network were obtained from experiments conducted at McCorkle Nurseries. The use of sensors increased profit substantially, mainly due to reduction in the time from planting to sale. Reductions in disease mortality and disease treatment costs were also substantial sources of increased profitability. Results of this analysis were reported in a paper published in HortTechnology (Lichtenberg et al. 2013).
2. ***Pot-in-Pot Tree Production in Tennessee.*** Data on water use and irrigation management costs with and without a sensor network were used to estimate profitability in pot-in-pot container production at Hale and Hines nursery. The sensor network reduced both irrigation water application and irrigation management time by at least half. Even though water costs consist only of the cost of pumping water from a nearby river, investment in the wireless sensor network yielded a high rate of return. Sensitivity analysis indicated that sensor networks would be even more profitable in areas where water is scarce and costly (e.g., California). Results of this analysis were reported in a paper published in HortTechnology (Belayneh et al. 2013).
3. ***Snapdragon Production in Maryland.*** Data from production and sales records from our greenhouse snapdragon partner were used to estimate the effects of wireless sensor networks on yield and quality. Statistical analysis of the production data showed that wireless sensor networks accelerated production time and increased yields. One additional crop was harvested annually, while yields increased from 5% to 80%, depending on cultivar. Statistical analysis of the combined sales and production data showed that wireless sensor networks increased quality (shares of grade 1 and 2 snapdragons at the expense of grade 3 stems) and thus increased the average price received for most cultivars. Increases in yield and improvements in quality resulted in a high rate of return on investment. A paper reporting these results has been submitted to the journal Irrigation Science.

### 2. Adoption Prospects of Wireless Sensor Networks

The economic team developed a national ornamental grower survey to better understand current perceptions of sensor-based irrigation technology. Data were collected from January 2012 to March 2013. A total of 268 useable responses were analyzed. These data have been used in two studies:

1. ***Grower perceptions of wireless sensor technology.*** Growers were asked about their positive and negative perceptions of these systems, to assess current receptivity of this technology. Grower

perceptions were overwhelmingly positive, with the majority of respondents agreeing that wireless sensor systems would provide a number of benefits including; increased irrigation efficiency, reduced product loss, reduced irrigation management costs, reduced disease prevalence, and reduced monitoring costs. System cost and reliability were major concerns. Grower perceptions of irrigation sensor networks varied across size and type of operation as well as geographically and by the type of water source used. Results of this analysis were reported in a paper published in HortTechnology (Majsztrik et al. 2013b).

2. **Grower willingness to pay for wireless sensor technology.** Growers were asked about their willingness to purchase (a) a base system and (b) additional nodes in order to assess likely initial adoption, potential speed of diffusion, and likely ceiling adoption of wireless sensor networks. A standard dichotomous choice format was used: They were asked whether they would purchase a base system at a given price. Then they were asked how many additional nodes they would purchase at a given price assuming they had already purchased a base system. Close to 20% of growers would purchase a base system at the expected initial market price, while roughly 30% would not purchase a base system at any price. Growers who purchased a base system were estimated to be willing to purchase an additional 3 nodes at the expected initial market price. Sensitivity analysis was used to estimate the response of initial adoption to changes in base system cost, perceptions about wireless sensor system advantages and disadvantages, and prices of additional nodes (Lichtenberg et al., 2014).

### 3. Calculating Public Benefits

Using data collected from a national grower survey that we developed, and additional national datasets, public benefits of sensor networks were estimated based on various assumed adoption rates. The higher return on investment and short payback periods the project has demonstrated suggest that the adoption rate of this type of technology is likely to increase over time. Environmental benefits were projected under a variety of scenarios for ornamental growers. For example, a conservative estimate of 50% industry adoption, with a 50% water savings would have the following impacts: enough water reduction to supply 400,000 households a year, reduced energy usage equivalent to removing 7,500 cars annually, and savings of 282,000 kg of nitrogen and 182,000 kg of phosphorus from entering the environment. Results of this analysis were reported in a paper published in Majsztrik et al. (2013a). Additionally, potential public benefits associated with use of sensor networks in several urban storm water best management practices were examined. The use of sensor networks in the design and implementation of green roofs, rain gardens and tree trenches have the potential to improve the success rate of these BMPs, increase their adoption rate, and improve verification for BMP credits.

### 4. Engaging Growers and the Industry on Benefits and Limitations of Sensor Networks

The economics team contributed three learning modules to the smart farms knowledge center ([www.smart-farms.org](http://www.smart-farms.org); See Section D). These modules are meant to help owners, irrigation managers, consultants and students better understand wireless irrigation sensor networks, and how they might benefit from implementing them at an ornamental operation. The Cost and Benefits module discusses the potential ways that sensor networks might benefit an operation. The Return on Investment module walks growers through the use of a spreadsheet, and the growers own information to develop a baseline cost of production, and the potential increase in profits by using a sensor network. The spreadsheet also estimates public (off-farm) benefits of adopting a sensor network. The Public Benefits module looks at the broader long-term impacts of more widespread adoption of sensor network technology across the country. Savings in water, carbon dioxide, nitrogen and phosphorus are calculated for 6 regions, as well as the Chesapeake Bay watershed based on a number of different scenarios.

## D. Outreach – Website and Knowledge Center Development

1. **Website** The SCRI-MINDS website was established at the outset of the project in September, 2009 with input from all team members. The domain name “Smart-Farm” was chosen for the project and the ‘dot net’ domain and ‘dot org’ names were purchased. The website can be viewed at

<http://www.smart-farms.net>

The website was redeveloped in year 4 (Fig. 37) to include all the new project information and allow for a gateway to the knowledge center at

<http://www.smart-farms.org>

which is hosted by the University of Maryland (see below)

The image shows a screenshot of the Smart Farms Knowledge Center website. At the top, there is a navigation bar with 'Smart Farms' and 'Knowledge Center' tabs. Below this is a header with the 'Smart Farms' logo and the tagline 'SCRI-MINDS—Managing Irrigation and Nutrition via Distributed Sensing', followed by the subtext 'saving water increasing efficiency reducing environmental impacts'. A main navigation menu includes 'HOME', 'APPROACH', 'ENVIRONMENTS', 'R&D TEAMS', 'RESEARCH SITES', 'PARTNERS', 'ECONOMICS', 'PUBLICATIONS', and 'IMPACTS'. The main content area features a 'Smart Farms Home' section with a list of links: 'Network Development', 'Direct Sensing Approach', 'Modeling Approach', and 'Advisory Panel'. To the right of this list is a group photo of the project team. Below the photo, there is a 'Smart Farms Home' section with three paragraphs of text: 'Our project is all about saving water, increasing efficiency and reducing the environmental impacts of ornamental plant production practices! We are using wireless sensor networks and environmental modeling to more accurately predict and apply irrigation water in nursery and greenhouse operations, and monitor green roofs for stormwater mitigation.', 'Our goal is to provide growers with the ability to precisely monitor and control applications of water and nutrients to plants in these production settings, based upon daily plant requirements.', and 'Our vision is to provide the nursery and greenhouse industries with cost-effective equipment and strategies that can be used to reduce the volume and cost of inputs, increase profitability, reduce the environmental impacts of nursery and greenhouse production and encourage sustainable practices in the United States and beyond.' To the right of this text is a technical diagram titled 'Local Irrigation Control' and 'Global Irrigation Control'. The diagram shows a 'Production Area / Irrigation Zone' with 'Sensors' and 'Irrigation' components. It also shows a 'Local Computer' connected to a 'Remote Server' and a 'Smartphone or Handheld Device'. The 'Global Irrigation Control' section includes 'Crop Models', 'Irrigation Schedules', and a 'Database'. The diagram is connected to a 'Data Station' and a 'Local Computer'.

Fig. 37. The SCRI-MINDS Website and Knowledge Center

## 2. Knowledge Center Development

Extension and outreach goals during Year 4 focused on planning and starting to develop a number of learning modules, which can be found by clicking the “Knowledge Center” tab at the top of the smart-farms website. This takes you to the <http://smart-farms.org> website. The links on this website (Fig. 33) take users directly into a series of secure learning modules, developed with the Canvas Content Management System (Fig. 37).

A total of 28 self-guided learning modules have been outlined, under seven main themes. These include (1) Before you Invest; (2) Your Existing Irrigation System; (3) Installation; (4) Tools; (5) Strategies; (6) Case-Studies and (7) Resources (Fig. 38). Within each of these themes, a number of discrete learning modules serve as self-guided tutorials on a wide range of topics related to system design, troubleshooting, economics and maintenance.

To date, seventeen modules have been completed (Fig. 38). Figures 39 and 40 illustrates an example of the layout and the content provided in each module within the Canvas learning management environment. Remaining learning modules on specific case studies will be completed in 2015 and highlight implementation of precision irrigation monitoring and control systems at partner grower locations.



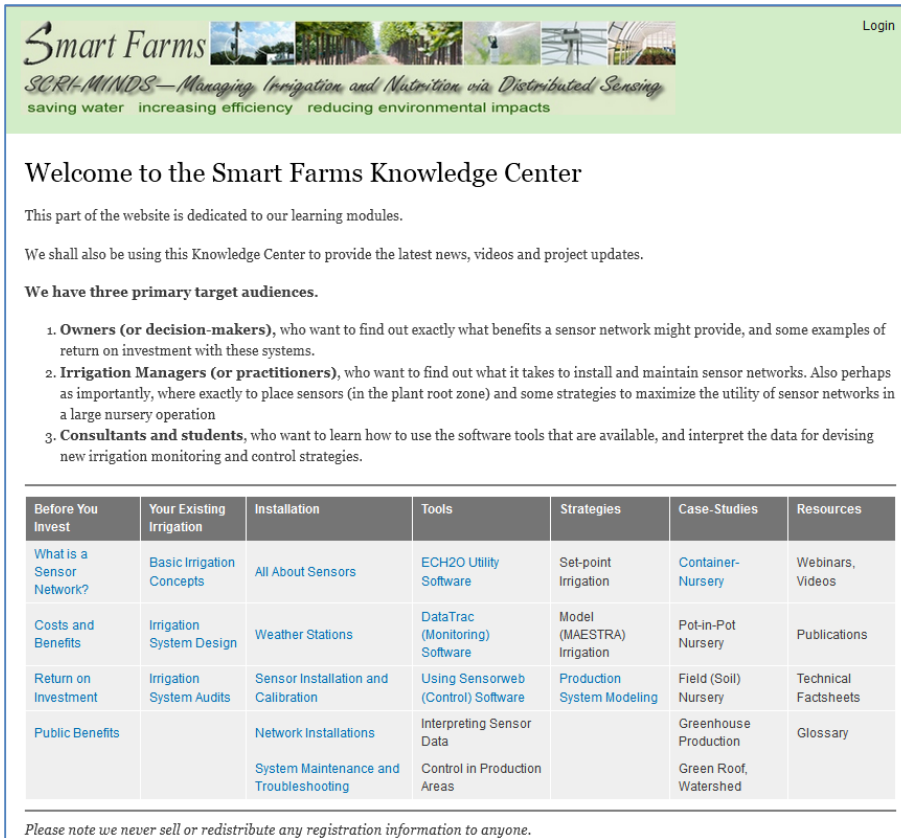

**Smart Farms**  
*SCRF-MINDS—Managing Irrigation and Nutrition via Distributed Sensing*  
 saving water increasing efficiency reducing environmental impacts

Login

## Welcome to the Smart Farms Knowledge Center

This part of the website is dedicated to our learning modules.

We shall also be using this Knowledge Center to provide the latest news, videos and project updates.

**We have three primary target audiences.**

- Owners (or decision-makers)**, who want to find out exactly what benefits a sensor network might provide, and some examples of return on investment with these systems.
- Irrigation Managers (or practitioners)**, who want to find out what it takes to install and maintain sensor networks. Also perhaps as importantly, where exactly to place sensors (in the plant root zone) and some strategies to maximize the utility of sensor networks in a large nursery operation
- Consultants and students**, who want to learn how to use the software tools that are available, and interpret the data for devising new irrigation monitoring and control strategies.

Before You Invest	Your Existing Irrigation	Installation	Tools	Strategies	Case-Studies	Resources
<a href="#">What is a Sensor Network?</a>	<a href="#">Basic Irrigation Concepts</a>	<a href="#">All About Sensors</a>	<a href="#">ECH2O Utility Software</a>	<a href="#">Set-point Irrigation</a>	<a href="#">Container-Nursery</a>	<a href="#">Webinars, Videos</a>
<a href="#">Costs and Benefits</a>	<a href="#">Irrigation System Design</a>	<a href="#">Weather Stations</a>	<a href="#">DataTrac (Monitoring) Software</a>	<a href="#">Model (MAESTRA) Irrigation</a>	<a href="#">Pot-in-Pot Nursery</a>	<a href="#">Publications</a>
<a href="#">Return on Investment</a>	<a href="#">Irrigation System Audits</a>	<a href="#">Sensor Installation and Calibration</a>	<a href="#">Using Sensorweb (Control) Software</a>	<a href="#">Production System Modeling</a>	<a href="#">Field (Soil) Nursery</a>	<a href="#">Technical Factsheets</a>
<a href="#">Public Benefits</a>		<a href="#">Network Installations</a> <a href="#">System Maintenance and Troubleshooting</a>	<a href="#">Interpreting Sensor Data</a> <a href="#">Control in Production Areas</a>		<a href="#">Greenhouse Production</a> <a href="#">Green Roof, Watershed</a>	<a href="#">Glossary</a>

*Please note we never sell or redistribute any registration information to anyone.*

Fig. 38. The Smart-farms Knowledge Center Homepage at <http://smart-farms.org>

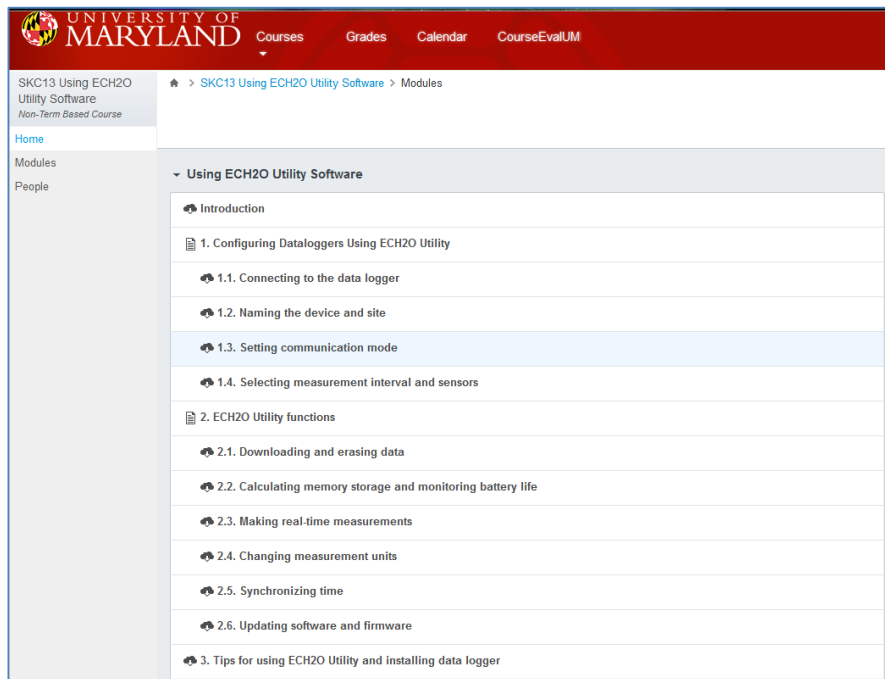

UNIVERSITY OF MARYLAND  
 Courses Grades Calendar CourseEvalUM

SKC13 Using ECH2O Utility Software  
 Non-Term Based Course

Home

Modules

People

Using ECH2O Utility Software

- Introduction
- 1. Configuring Dataloggers Using ECH2O Utility
  - 1.1. Connecting to the data logger
  - 1.2. Naming the device and site
  - 1.3. Setting communication mode
  - 1.4. Selecting measurement interval and sensors
- 2. ECH2O Utility functions
  - 2.1. Downloading and erasing data
  - 2.2. Calculating memory storage and monitoring battery life
  - 2.3. Making real-time measurements
  - 2.4. Changing measurement units
  - 2.5. Synchronizing time
  - 2.6. Updating software and firmware
- 3. Tips for using ECH2O Utility and installing data logger

Fig. 39. One of the knowledge center learning module homepages within Canvas, hosted by the University of Maryland

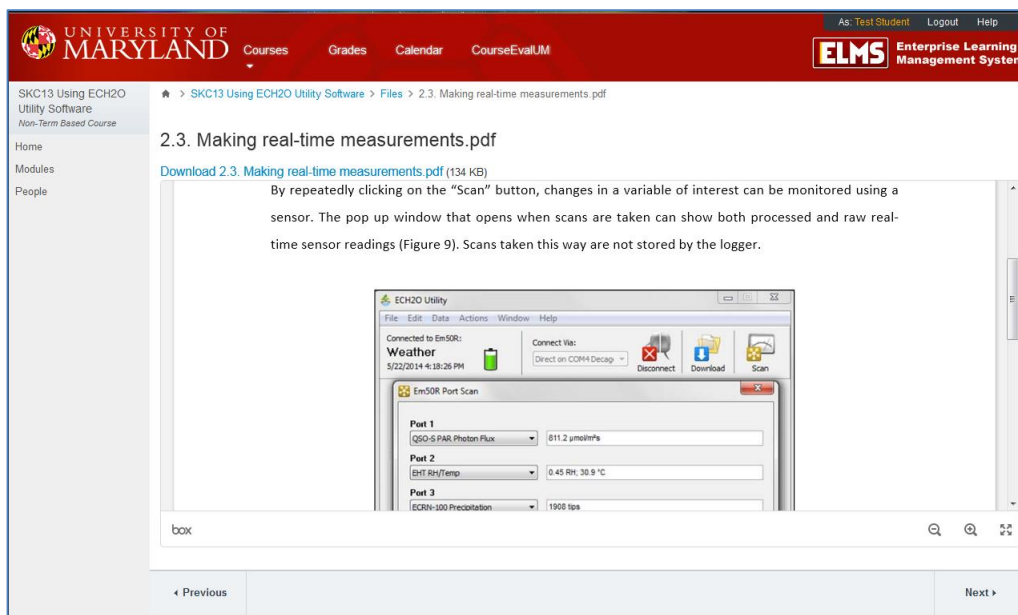

Fig. 40. Learning module page detail.

## E. Project Fiscal Management, Final Project Meeting - University of Maryland

### Fiscal Accounting and Matching Documentation

All subcontracts were finalized by the University of Maryland in August, 2014. Total project spending totaled \$4,887,832 whereas total match amounted to \$5,895,211. A total of \$273,663 was returned as unspent federal funds to the Federal Government. The final Year 5 Federal Financial report is attached as Appendix A.

### Final Project Meeting

The final annual project meeting was held from 9 – 10 June, 2014 in College Park, MD. In addition to the engineering and research faculty from the five Universities and companies, we were joined by nine of our advisory panel members, two postdoctoral researchers and five graduate students involved in various aspects of the project. Drs. Thomas Bewick and Dan Schmoltdt, our SCRI program leaders also joined us on this first day. During the first (reporting) day, we shared progress by the various working groups, starting with graduate student presentations.

The second day was devoted to in-depth discussions about the submission of a SCRI-MINDS II proposal, in various break-out groups. Many ideas were shared and finalized, culminating in a proposal submission to USDA-SCRI program in July, 2014.

The third day was devoted to an intensive round of visits to USDA-NIFA Headquarters where we met with NIFA Director, Dr. Sonny Ramaswamy and Undersecretary of Agriculture, Dr. Catherine Woteki. This was followed by visits to Capitol Hill, organized by Jonathan Moore, Legislative Affairs officer under the auspices of the American Society for Horticultural Science. Two groups of team members and growers visited over sixteen legislative offices in both the House and Senate, to inform members and their staff about the SCRI-MINDS project and the direct benefits of the project, and of the SCRI program, as attested to by our growers.

## F. Training and Professional Development Opportunities

In total, the SCRI-MINDS project has supported the activities of the following students, post-doctoral associates and visiting scientists.

### **Fourteen Graduate Research Assistantships (GRAs):**

- **Eleven PhD students:** Jongyun Kim, Alem Peter, Mandy Bayer (UGA); Daniel Voica, Olyssa Starry, Whitney Gaches, Daniel Voica, Monica Saavedra, Ian Page (UM); David Barnard (CSU) and Annika Kreye (Cornell)
- **Four MS students:** Clark de Long (UM), Will Wheeler and Alex Litvin (UGA); Gretchen Reuning (CSU)

**Nine Undergraduate Research Internships:** Liam Monahan, James Zazanis, Zach Beichler, Ian Reichardt, Taylor Boone, Rachel Kierzewski and Kenneth Hunsley (UM); Kevin Whitaker (UGA) and Dan Banks (CSU)

**Four Postdoctoral Research Fellowships:** Dr. Jongyun Kim and Dr. John Majsztrik (UM), Dr. Rhuanito Soranz Ferrarezi (UGA) and Dr. Michela Centinari (Cornell)

**Four visiting scientists:** Dr. Kang Jong-Goo (S. Korea) and Rhuanito Soranz Ferrarezi (Brazil); Dr. Martin Gsplantl and Dr. Otavio Campoe (UGA)

## G. Publications, Presentations and Outreach

### Book Chapters

1. Kong, P. and J. D. Lea-Cox. 2014. Water Quality Dynamics: Implications for Managing Waterborne Pathogens. Chapter 27. *In: Biology, Detection and Management of Plant Pathogens in Irrigation Water*. C. H. Hong, G. W. Moorman and W. Wohanka (Eds.). American Phytopathology Society. St. Paul, MN. pp. 333-346.
2. Lea-Cox, J. D. and D. S. Ross. 2014. Water Management to Minimize Pathogen Movement in Containerized Production Systems. Chapter 30. *In: Biology, Detection and Management of Plant Pathogens in Irrigation Water*. C. H. Hong, G. W. Moorman and W. Wohanka (Eds.). American Phytopathology Society. St. Paul, MN. pp. 377-387.
3. Ristvey, A.G. and G.W. Moorman. 2014. An Integrated Approach to Minimizing Plant Pathogens in Runoff Water from Containerized Production Systems. Chapter 29 *In: Biology, Detection, and Management of Plant Pathogens in Irrigation Water*. C. X. Hong, G. W. Moorman, W. Wohanka, and C. Büttner, eds. American Phytopathological Society, St. Paul, MN. pp. 365-375.

### Peer-Reviewed Journal Articles

1. Alem, P., P. A. Thomas, and M.W. van Iersel. 2014. Use of controlled water deficit to regulate poinsettia stem elongation. Achievable heights. *HortScience* (in press)
2. Ali A.A., C. Xu, A. Rogers, N.G. McDowell, B.E. Medlyn, R. Fisher, S.D. Wullschelger, P.P. Reich, J.A. Vrugt, W.L. Bauerle, L.S. Santiago, and C.J. Wilson. 201x. The environmental control of plant photosynthetic capacity at the global scale. *Ecological Applications*, *In Review*.
3. Bauerle, W.L., A.B. Daniels, and D.M. Barnard. 2014. Carbon and water flux responses to physiology by environment interactions: A sensitivity analysis of variation in climate on photosynthetic and stomatal parameters. *Climate Dynamics*, 42:2539-2554.
4. Bauerle, T.L. W.L. Bauerle, M. Goebel, and D.M. Barnard. 2013. Root system distribution influences substrate moisture measurements in containerized ornamental tree species *HortTechnology*, 23:754-759.
5. Barnard, D.M. and W.L. Bauerle. 201x. Species-specific irrigation scheduling with a spatially explicit biophysical model: a comparison to substrate moisture sensing with insight into simplified physiological parameterization. *Agricultural and Forest Meteorology*, *In Review*.
6. Bayer, A., J. Ruter, and M.W. van Iersel. 2014. Automated Irrigation Control for Improved Growth and Quality of *Gardenia jasminoides* 'Radicans' and 'August Beauty'. *HortScience* (in press).
7. Belayneh, B.E., J. D. Lea-Cox, and E. Lichtenberg. 2013. Benefits and costs of implementing sensor-controlled irrigation in a commercial pot-in-pot container nursery. [HortTechnology 23:760-769](#).
8. Chappell, M., S.K. Dove, M. W van Iersel, P.A Thomas and J. Ruter. 2013. Implementation of Wireless Sensor Networks for Irrigation Control in Three Container Nurseries. [HortTechnology 23: 747-753](#)
9. Ferrarezi, R.S., M.W. van Iersel and R. Testezlaf. 2014. Subirrigation automated by capacitance sensors for salvia production. *Horticultura Brasileira* 32:314-320. (DOI: <http://dx.doi.org/10.1590/S0102-05362014000300013>)
10. Ferrarezi, R.S., S.K. Dove, and M.W. van Iersel. 2014. An automated system for monitoring soil moisture and controlling irrigation using Arduino microcontrollers. *HortTechnology* (in press).
11. Fletcher, R.S., J.L. Mullen, S. Yoder, W.L Bauerle, G. Reuning, S. Sen, E. Meyer, T.E. Juenger, and J.K. McKay. 2013. Development of a next-generation NIL library in *Arabidopsis thaliana* for dissecting complex traits. *BMC Genomics*,14:655. <http://www.biomedcentral.com/1471-2164/14/65>

12. Hu, H., G.G. Wang, G.G., W.L. Bauerle, and R. Klos. 201x. Drought impact on forest regeneration in the Southeast USA. *Ecological Applications*, In Review.
13. Kohanbash, D., G. F. Kantor, T. Martin and L. Crawford. 2013. Wireless Sensor Network Design for Monitoring and Irrigation Control: User-centric Hardware and Software Development. [HortTechnology 23:725-734](#).
14. Lea-Cox, J. D., W.L. Bauerle, M.W. van Iersel, G.F. Kantor, T.L. Bauerle, E. Lichtenberg, D.M. King and L. Crawford. 2013. Advancing Wireless Sensor Networks for Irrigation Management of Ornamental Crops: An Overview. [HortTechnology 23:717-724](#).
15. Lichtenberg, E., J. C. Majsztrik and M. Saavoss. 2013. Profitability of Sensor-Based Irrigation in Greenhouse and Nursery Crops. [HortTechnology 23:770-774](#).
16. Lichtenberg, E., J. Majsztrik and M. Saavoss. 2014. Grower demand for sensor-controlled irrigation. *Water Resources Research*. (In Press).
17. Majsztrik, J. C., E. Lichtenberg and M. Saavoss. 2013. Ornamental Grower Perceptions of Sensor Networks. [HortTechnology 23: 775-782](#).
18. Majsztrik, J. C., E. W. Price and D. M. King. 2013. Environmental Benefits of Wireless Sensor-based Irrigation Networks: Case-study Projections and Potential Adoption Rates. [HortTechnology 23:783-793](#).
19. Majsztrik, J.C., A. G. Ristvey, E. Lichtenberg and J.D. Lea-Cox. 2013. 2012 Maryland Horticulture Industry Economic Profile. *Maryland Nursery and Landscape Association*, Brooklandville. MD. Dec, 2013. 40 p. [http://issuu.com/marylandnurserylandscapeassn/docs/final\\_report\\_-\\_dec\\_23\\_2013](http://issuu.com/marylandnurserylandscapeassn/docs/final_report_-_dec_23_2013)
20. O'Meara, L., M.R. Chappell, and M.W. van Iersel. 2014. Water use of *Hydrangea macrophylla* and *Gardenia jasminoides* in response to a gradually drying substrate. *HortScience* 49:493-498.
21. Reuning G.A, W.L. Bauerle, J.L. Mullen, and J.K. McKay. 2014. Combining quantitative trait loci analysis with physiological models to predict genotype specific transpiration rates. *Plant, Cell and Environment*, In Press, DOI: 10.1111/pce.12429.
22. Saavoss, M., J. Majsztrik, B. Belayneh, J. Lea-Cox and E. Lichtenberg. 2014. Yield, Quality, and profitability of sensor-controlled irrigation: a case study of snapdragon (*Antirrhinum majus* L.) production. *Irrigation Science*, In Review
23. Starry, O., J.D. Lea-Cox, J. Kim, and M.W. van Iersel. 2014. Photosynthesis and water use by two *Sedum* species in green roof substrate. *Environmental and Experimental Botany* 107:105-112. (DOI: [10.1016/j.envexpbot.2014.05.014](#))
24. Stoy, P.C., A.M. Trowbridge, and W.L. Bauerle. 2014. Controls on seasonal patterns of maximum ecosystem carbon uptake and canopy-scale photosynthetic light response: contributions from both temperature and photoperiod. *Photosynthesis Research*, 119: 49-64.
25. van Iersel, M.W., M. Chappell, and J. D. Lea-Cox. 2013. Sensors for improved efficiency of irrigation in greenhouse and nursery production. [HortTechnology. 23:735-746](#).
26. Zhen, S., S.E. Burnett, M.E. Day, and M.W. van Iersel. 2014. Effects of substrate water content on morphology and physiology of rosemary, Canadian columbine, and cheddar pink. *HortScience* 49:486-492.

### Refereed Conference proceedings

1. Alem, P.O., P.A. Thomas, and M.W. van Iersel. 2014. Irrigation volume and fertilizer concentration effects on leaching and growth of petunia. *Acta Horticulturae* 1034:143-148.
2. Bayer, A. K. Whitaker, M. Chappell, J. Ruter, and M. van Iersel. 2014. Effect of irrigation duration and fertilizer rate on plant growth, substrate solution EC, and leaching volume. *Acta Horticulturae* 1034: 477-484.

3. Bayer, A., J. Ruter and M. van Iersel. 2013. Automated irrigation control for improved growth and quality of *Gardenia jasminoides*. *Acta Horticulturae* 1014:407-411.
4. Lea-Cox, J.D and B.E. Belayneh. 2014. Implementation of sensor-controlled decision irrigation scheduling in pot-in-pot nursery production. [Acta Horticulturae 1034:93-100](#).
5. Kim, J., J.D. Lea-Cox, M. Chappell, and M.W. van Iersel. 2014. Wireless sensors networks for optimization of irrigation, production, and profit in ornamental production. [Acta Horticulturae 1037:643-649](#).
6. Starry, O., J.D. Lea-Cox, A.G Ristvey and S. Cohan. 2014. Monitoring and Modeling Green Roof Performance Using Sensor Networks. [Acta Horticulturae 1037:663-669](#).
7. van Iersel, M.W. and S.K. Dove. 2014. Temporal dynamics of oxygen concentrations in a peat-perlite substrate. *Acta Horticulturae* 1034:355-361.

### **Non-Refereed Conference Proceedings**

1. Hagan, P., E. Price, and D. King. 2014. Potential public benefits of using wireless sensor networks to manage urban stormwater. Reference number (UMCES) CBL 2014-053.

### **Trade Articles, Reports**

1. van Iersel, M.W., R.T. Fernandez, and J. Lea-Cox. 2014. Improving operation profitability via wise water use. Cultivate 2014 handout, 2 pp.
2. van Iersel, M.W., M.R. Chappell, and P.A. Thomas. 2014. Precision irrigation in greenhouses and nurseries: Improving production and increasing profits. 56th Annual Horticulture Growers' Short Course 2014 Proceedings: 134-135.
3. Melancon, M., M. Chappell, M. van Iersel and P. Thomas. 2013. [Water Use Slashed: Study Shows Sensor System Reduced Nursery Water Use](#). Georgia Urban Agriculture Council Magazine. Nov/Dec 2013:56-57.

### **Invited presentations**

1. Chappell, M. 2014. Integrating wireless sensor networks that monitor and control irrigation into existing irrigation schemes: 3 case studies. X Curso Internacional Sobre Programacion de Riegos. Lleida, Spain. April 2014.
2. Chappell, M. 2014. Expanding the versatility of wireless sensor networks beyond simply controlling irrigation. X Curso Internacional Sobre Programacion de Riegos. Lleida, Spain. April 2014.
3. Lea-Cox, J.D. and C. Bauer. 2014. Research on cutting edge water technologies and Perspective of a grower adopting such technologies. Seeley Summit: Water - Horticulture's Next Game Changer? Cornell University. 23 June, 2014. Chicago, IL.

### **Abstracts, Conference Presentations**

1. Alem P.O., M. van Iersel, and P. Thomas. 2014. Modeling water use of bedding plants as a function of light interception. *HortScience* 49(9):S122.
1. Bayer, A., J.M. Ruter, M. van Iersel. 2014. Elongation of *Hibiscus acetosella* 'Panama Red' in well-watered and water-stressed conditions. *HortScience* 49(9):S226.
2. Belayneh, B.E., D. Kohansbash and J.D. Lea-Cox. 2014. Scaling Sensor Networks for Scheduling Irrigations in a Commercial Pot-in-Pot Nursery. *HortScience* 49(9):S137.

3. Burnett, S., S. Dove, R.S. Ferrarezi, J.G. Kang, and M. van Iersel. 2014. Automated fertigation and irrigation control based on measurements of substrate water content and pore water EC. *HortScience* 49(9):S230.
4. Burnett, S.E. and M. van Iersel. 2014. Effects of low substrate oxygen on plant growth. *HortScience* 49(9):S358.
5. Chappell, M. Paul Thomas, J. Lea-Cox, M. van Iersel, L. Crawford, B. Belayneh, J. Majsztrik, W. Bauerle, T. Bauerle, D. King, D. Kohanbash, E. Lichtenberg, and A. Ristvey. 2014. Using online learning modules as a tool for delivering complex information to SCRI stakeholders. *HortScience* 49(9):S313-314.
6. Chappell, M. and M. van Iersel. 2014. Implementing Precision Irrigation Technology in a Commercial Nursery: A Case Study on Adoption and Expansion. *HortScience* 49(9):S30.
7. Ferrarezi, R.S. P.O. Alem, and M. van Iersel. 2014. Prediction of pore water electrical conductivity using real dielectric and bulk electrical conductivity in soilless substrates. *HortScience* 49(9):S165-166.
8. Ferrarezi, R.S., S. Dove, and M. van Iersel. 2014. A low cost, Arduino-based system for monitoring and controlling substrate water content. *HortScience* 49(9):S264-265.
9. Lea-Cox, J.D. Partnering with Commercial Growers to Implement Sensor-based Irrigation Control. *HortScience* 49(9):S105.
10. Lea-Cox, J.D., B.E. Belayneh, D. Kohanbash and R. Conrad. 2014. Scaling Sensor Networks to Estimate Horticultural Crop Water Use in a Watershed in Ecuador. *HortScience* 49(9):S123.
11. Lichtenberg, E., J. Majsztrik and M. Saavoss. 2014. Grower demand for sensor-controlled irrigation. Poster presented at the annual meeting of the Agricultural and Applied Economics Association, Minneapolis, MN, July 27-29, 2014.
12. Litvin, A.G., M. van Iersel, and A. Malladi. 2014. Daily water use of tomato plants as affected by environmental conditions and plant age. *HortScience* 49(9):S213.
13. Majsztrik, J., D. King, and E. Price. 2014. Public benefits of wireless sensor irrigation network adoption. *HortScience* 49(9):S173
14. Majsztrik, J., M. Saavoss, and E. Lichtenberg. 2014. How much are ornamental growers willing to pay for irrigation technology? *HortScience* 49(9):S173.
15. Ristvey, A. G., B. Belayneh, J.P. Zazanis, J. Beaulieu, Y. Balci and J.D. Lea-Cox. 2014. Investigating Alternative Pathogen Management through Sensor-driven Irrigation. *HortScience* 49(9): S226-227.
16. Starry, O., W. Griffin, B.E. Belayneh, D. Kohanbash and J.D. Lea-Cox. 2014. Using Scaled Sensor Networks to Estimate Green Roof Stormwater Runoff. *HortScience* 49(9): S136-137.
17. van Iersel, M., S. Dove, J.S. Owen Jr. 2014. Hydraulic properties of peat-based substrates: the importance of hydraulic conductance. *HortScience* 49(9):S122.
18. White, S.A., J.S. Owen, J.C. Majsztrik, R.T. Fernandez, P. Fisher, C.R. Hall, T. Irani, J.D. Lea-Cox, J.P. Newman and L.R. Oki. 2014. Grower Priorities for Water Research: Results of a SCRI Planning Grant. *HortScience* 49(9):S35.

### Online Learning Modules

1. Belayneh, B.E. 2014. Sensor Installation and Calibration. *In: Managing Irrigation through Distributed Networks Knowledge Center*, M. Chappell, P. Thomas and J.D. Lea-Cox (Eds.). Module 10. Published online at: <https://myelms.umd.edu/courses/1110352> \_\_p.
2. Belayneh, B.E. 2014. Network Installations. *In: Managing Irrigation through Distributed Networks Knowledge Center*, M. Chappell, P. Thomas and J.D. Lea-Cox (Eds.). Module 11. Published online at: <https://myelms.umd.edu/courses/1110353> \_\_p.

3. Belayneh, B.E. 2014. System Maintenance and Troubleshooting. *In: Managing Irrigation through Distributed Networks Knowledge Center, M. Chappell, P. Thomas and J.D. Lea-Cox (Eds.).* Module 12. Published online at: <https://myelms.umd.edu/courses/1110354> \_\_p.
4. Belayneh, B.E. 2014. Using ECH2O Utility Software. *In: Managing Irrigation through Distributed Networks Knowledge Center, M. Chappell, P. Thomas and J.D. Lea-Cox (Eds.).* Module 13. Published online at: <https://myelms.umd.edu/courses/1092859> 14p.
5. Belayneh, B.E. 2014. Using DataTrac 3 Software. *In: Managing Irrigation through Distributed Networks Knowledge Center, M. Chappell, P. Thomas and J.D. Lea-Cox (Eds.).* Module 14. Published online at: <http://myelms.umd.edu/courses/1110350> 20p.
6. Chappell, M. and M. van Iersel 2014. Container nursery case-studies. *In: Managing Irrigation through Distributed Networks Knowledge Center, M. Chappell, P. Thomas and J.D. Lea-Cox (Eds.).* Module 21. Published online at: <https://myelms.umd.edu/courses/1110361> \_\_p.
7. Chappell, M., P. Thomas and M. van Iersel. 2014. What is a sensor network? *In: Managing Irrigation through Distributed Networks Knowledge Center, M. Chappell, P. Thomas and J.D. Lea-Cox (Eds.).* Module 1. Published online at: <https://myelms.umd.edu/courses/775817> \_\_p.
8. Kohanbash, D. 2014. Using Sensorweb software. *In: Managing Irrigation through Distributed Networks Knowledge Center, M. Chappell, P. Thomas and J.D. Lea-Cox (Eds.).* Module 15. Published online at: <https://myelms.umd.edu/courses/1110355> \_\_p.
9. Majsztrik, J., D King, and E. Price. 2014. Understanding the public benefits of sensor networks. *In: Managing Irrigation through Distributed Networks Knowledge Center, M. Chappell, P. Thomas and J.D. Lea-Cox (Eds.).* Module 4. Published online at: <https://myelms.umd.edu/courses/1110348> 17p.
10. Majsztrik, J., E. Lichtenberg, and M. Saavoss. 2014. Costs and benefits of wireless sensor networks: How a sensor network might benefit your operation. *In: Managing Irrigation through Distributed Networks Knowledge Center, M. Chappell, P. Thomas and J.D. Lea-Cox (Eds.).* Module 2. Published online at: <https://myelms.umd.edu/courses/1110342> 18p.
11. Majsztrik, J., E. Lichtenberg, M. Saavoss, E. Price, D. King. 2014. Return on Investment: Deciding if a sensor network is right for your operation. *In: Managing Irrigation through Distributed Networks Knowledge Center, M. Chappell, P. Thomas and J.D. Lea-Cox (Eds.).* Module 3. Published online at: <https://myelms.umd.edu/courses/1110347> 15p.
12. Majsztrik, J., A. G. Ristvey and J.D. Lea-Cox. 2014. Production system modeling. *In: Managing Irrigation through Distributed Networks Knowledge Center, M. Chappell, P. Thomas and J.D. Lea-Cox (Eds.).* Module 20. Published online at: <https://myelms.umd.edu/courses/973824> 15p.
13. Ross, D.S. 2014. Basic Irrigation Concepts. *In: Managing Irrigation through Distributed Networks Knowledge Center, M. Chappell, P. Thomas and J.D. Lea-Cox (Eds.).* Module 5. Published online at: <https://myelms.umd.edu/courses/969642> 26p.
14. Ross, D.S. 2014. Irrigation System Design and Components. *In: Managing Irrigation through Distributed Networks Knowledge Center, M. Chappell, P. Thomas and J.D. Lea-Cox (Eds.).* Module 6. Published online at: <https://myelms.umd.edu/courses/969635> 29p.
15. Ross, D.S. 2014. Irrigation System Audits. *In: Managing Irrigation through Distributed Networks Knowledge Center, M. Chappell, P. Thomas and J.D. Lea-Cox (Eds.).* Module 7. Published online at: <https://myelms.umd.edu/courses/969638> 33p.
16. van Iersel, M. and M. Chappell 2014. All about sensors. *In: Managing Irrigation through Distributed Networks Knowledge Center, M. Chappell, P. Thomas and J.D. Lea-Cox (Eds.).* Module 8. Published online at: <https://myelms.umd.edu/courses/1110349> \_\_p.
17. van Iersel, M. 2014. Weather Stations. *In: Managing Irrigation through Distributed Networks Knowledge Center, M. Chappell, P. Thomas and J.D. Lea-Cox (Eds.).* Module 9. Published online at: <https://myelms.umd.edu/courses/1110351> \_\_p.



## Webinars

1. Alem P.O., M. van Iersel, and P. Thomas. 2014. Modeling water use of bedding plants as a function of light interception. <https://ashs.confex.com/ashs/2014/vidgateway.cgi/id/580?recordingid=580>
2. Bayer, A., J.M. Ruter, M. van Iersel. 2014. Elongation of *Hibiscus acetosella* 'Panama Red' in well-watered and water-stressed conditions. <https://ashs.confex.com/ashs/2014/vidgateway.cgi/id/799?recordingid=799>
3. Belayneh, B.E., D. Kohansbash and J.D. Lea-Cox. 2014. Scaling Sensor Networks for Scheduling Irrigations in a Commercial Pot-in-Pot Nursery. <https://ashs.confex.com/ashs/2014/vidgateway.cgi/id/899?recordingid=899>
4. Burnett, S., S. Dove, R.S. Ferrarezi, J.G. Kang, and M. van Iersel. 2014. Automated fertigation and irrigation control based on measurements of substrate water content and pore water EC. <https://ashs.confex.com/ashs/2014/vidgateway.cgi/id/492?recordingid=492>
5. Ferrarezi, R.S. P.O. Alem, and M. van Iersel. 2014. Prediction of pore water electrical conductivity using real dielectric and bulk electrical conductivity in soilless substrates. <https://ashs.confex.com/ashs/2014/vidgateway.cgi/id/553?recordingid=553>
6. Lea-Cox, J.D. 2014. Pathogen Recycling Risk Mitigation through System Design and Best Irrigation Management Practices <https://connect.extension.iastate.edu/p514ujen4de> In: Irrigation Pathogens and Water Quality <http://www.irrigation-pathogens.ppws.vt.edu/> 3 June, 2014.
7. Lea-Cox, J.D., B.E. Belayneh, D. Kohanbash and R. Conrad. 2014. Scaling Sensor Networks to Estimate Horticultural Crop Water Use in a Watershed in Ecuador. <https://ashs.confex.com/ashs/2014/vidgateway.cgi/id/891?recordingid=891>
8. Lea-Cox, J.D. Partnering with Commercial Growers to Implement Sensor-based Irrigation Control <https://ashs.confex.com/ashs/2014/vidgateway.cgi/id/869?recordingid=869>
9. Litvin, A.G., M. van Iersel, and A. Malladi. 2014. Daily water use of tomato plants as affected by environmental conditions and plant age. <https://ashs.confex.com/ashs/2014/vidgateway.cgi/id/566?recordingid=566>
10. Majsztrik, J., D. King, and E. Price. 2014. Public benefits of wireless sensor irrigation network adoption. <https://ashs.confex.com/ashs/2014/vidgateway.cgi/id/785?recordingid=785>
11. Majsztrik, J., M. Saavoss, and E. Lichtenberg. 2014. How much are ornamental growers willing to pay for irrigation technology? <https://ashs.confex.com/ashs/2014/vidgateway.cgi/id/781?recordingid=781>
12. Ristvey, A.G. 2014. Substrate management practices vital for pathogen risk mitigation. <https://connect.extension.iastate.edu/p8a3yfy8s2> In: Irrigation Pathogens and Water Quality <http://www.irrigation-pathogens.ppws.vt.edu/> 6 May, 2014.
13. Ristvey, A. G., B. Belayneh, J.P. Zazanis, J. Beaulieu, Y. Balci and J.D. Lea-Cox. 2014. Investigating Alternative Pathogen Management through Sensor-driven Irrigation. <https://ashs.confex.com/ashs/2014/vidgateway.cgi/id/814?recordingid=814>
14. Starry, O., W. Griffin, B.E. Belayneh, D. Kohanbash and J.D. Lea-Cox. 2014. Using Scaled Sensor Networks to Estimate Green Roof Stormwater Runoff. <https://ashs.confex.com/ashs/2014/vidgateway.cgi/id/977?recordingid=977>
15. van Iersel, M., S. Dove, J.S. Owen Jr. 2014. Hydraulic properties of peat-based substrates: the importance of hydraulic conductance. <https://ashs.confex.com/ashs/2014/vidgateway.cgi/id/541?recordingid=541>

## Other Presentations

1. Bauerle T.L. 2014. Getting to the root of the matter: coupling plant root characteristics to plant water use. 6<sup>th</sup> Annual Biotechnology Symposium: opening the biotechnology toolbox. SUNY-ESF, Syracuse, NY.
2. Bauerle T.L. 2014. Landscape update: The root connection: selecting the right plants for difficult situations. Sustainable Horticulture Webinar series hosted by Cornell Cooperative Extension.
3. Chappell M. 2014. IPM for Nursery Production Workshop. Measuring physical soil properties to improve plant growth and disease management. Winchester, TN.
4. Chappell M. 2014. IPM for Nursery Production Workshop. Measuring physical soil properties to improve plant growth and disease management. Raleigh, NC.
5. Chappell, M. 2014. Precision irrigation saves water, time, money and heartache: A quick story of how research, extension and industry solve the big problems of agriculture. 2014 Southeastern State Experiment Station Directors Emeritus Meeting. Athens, GA.
6. Dinwiddie, J., M. van Iersel, B. Clegg, M. Nuccio, M. de Carbonnel, Y. Suna, A. Zhoua, G. Crabb, J. Nichols, H. Zhou, and N. Bate. 2014. An automated whole plant phenotyping system for high resolution characterization of plant x environment interactions. Maize genetics conference, Beijing, China.
7. Dinwiddie, J, M. van Iersel, B. Clegg, M. Nuccio, M. de Carbonnel, Y. Sun, A. Zhou, G. Crabb, J. Nichols, H. Zhaou, and N. Bate. 2014. A whole-plant phenotyping approach leveraging Syngenta's advanced crop laboratory at the research triangle park innovation center. 2014 Meeting of NCERA-101, Fairbanks, AK.
8. Lea-Cox, J., T. Fernandez, and M.W. van Iersel. 2014. Improving operation profitability via wise water use. Part 2. Cultivate 2014 (AmericanHort Tradeshow), Columbus, OH.
9. Lichtenberg, E., J. Majsztrik and M. Saavoss. 2014. Grower demand for sensor-controlled irrigation. SCRI-MINDS Annual Conference, College Park, MD, June 9-10, 2014.
10. Majsztrik, J., E. Lichtenberg, and M. Saavoss. 2014. Investing in Precision: A case study of flowers by Bauers. SCRI\_MINDS Annual Conference, College Park, MD. June 9-10 2014.
11. Saavoss, M., J. Majsztrik, B. Belayneh, J. Lea-Cox and E. Lichtenberg. 2014. Yield, Quality, and profitability of sensor-controlled irrigation: a case study of snapdragon (*Antirrhinum majus* L.) production. SCRI-MINDS Annual Conference, College Park, MD, June 9-10, 2014.
12. van Iersel, M.W., J. Lea-Cox, and T. Fernandez. 2014. Improving operation profitability via wise water use. Part 1. Cultivate 2014 (AmericanHort Tradeshow), Columbus, OH.
13. van Iersel, M.W., M. Chappell, and P.A. Thomas. 2014. Precision irrigation in greenhouses and nurseries: improving production and increasing profits. Horticulture Growers Short Course. Lower Mainland Horticulture Improvement Association, Pacific Agriculture Show, Abbotsford, BC.

## Theses and Dissertations

1. Reuning, G.A. 2014. M.S. Minimum stomatal conductance: implications for describing the genetic control of transpiration. MS. Thesis. Colorado State University.
2. Barnard, D.M. 2014. An Analysis of the Physiology and Environmental Interactions that Influence Species-Specific Transpiration Estimates. PhD Dissertation. Colorado State University.
3. Peter, A. 2014. Irrigation, fertilization and non-chemical plant growth regulation in greenhouse production. PhD Dissertation. The University of Georgia. August, 2014.
4. Bayer, A. 2014. Improving growth and quality of *Hibiscus acetosella* and *Gardenia jasminoides* with efficient irrigation and fertilization for more sustainable container plant production. PhD Dissertation. The University of Georgia December, 2014.

5. Starry, O. 2013. The Comparative Effects of Three Sedum Species on Green Roof Stormwater Retention. PhD Dissertation. The University of Maryland. August, 2013. 142p.
6. DeLong, C. 2013. Evaluation of Plant Species for Survival, Growth and Contribution to Green Roof Function. MS Thesis. The University of Maryland. December, 2013. 83p.
7. Griffin, W., 2014. Extensive Green Roof Substrate Composition: Effects of Physical Properties on Matric Potential, Hydraulic Conductivity, Plant Growth and Stormwater Retention in the Mid-Atlantic. PhD Dissertation. The University of Maryland. May, 2014. 172p.

Appendix A:

FEDERAL FINANCIAL REPORT

(Follow form instructions)

1. Federal Agency and Organizational Element to Which Report is Submitted <b>USDA NIFA</b>		2. Federal Grant or Other Identifying Number Assigned by Federal Agency (To report multiple grants, use FFR Attachment) <b>Award #20095118105768</b>				Page <b>1</b>	of <b>1</b>
3. Recipient Organization (Name and complete address including Zip code) <b>UNIVERSITY OF MARYLAND, OFFICE OF THE COMPTROLLER, CONTRACT AND GRANT ACCOUNTING ROOM 4101, CHESAPEAKE BUILDING, COLLEGE PARK, MD 20742-3141</b>							
4a. DUNS Number <b>790934285</b>	4b. EIN <b>526002033</b>	5. Recipient Account Number or Identifying Number (To report multiple grants, use FFR Attachment) <b>525317/525336</b>			6. Report Type Quarterly Semi-Annual <input checked="" type="checkbox"/> Annual Final	7. Basis of Accounting <input checked="" type="checkbox"/> CASH <input type="checkbox"/> ACCRUAL	
8. Project/Grant Period From: (Month, Day, Year) <b>9/1/2009</b>		To: (Month, Day, Year) <b>8/31/2014</b>		9. Reporting Period End Date (Month, Day, Year) <b>8/31/2014</b>			
10. Transactions						Cumulative	
<i>(Use lines a-c for single or multiple grant reporting)</i>							
<b>Federal Cash (To report multiple grants, also use FFR Attachment):</b>							
a. Cash Receipts						\$4,915,290.13	
b. Cash Disbursements						\$4,887,832.25	
c. Cash on Hand (line a minus b)						\$27,457.88	
<i>(Use lines d-o for single grant reporting)</i>							
<b>Federal Expenditures and Unobligated Balance:</b>							
d. Total Federal funds authorized						\$5,161,495.00	
e. Federal share of expenditures						\$4,887,832.25	
f. Federal share of unliquidated obligations							
g. Total Federal share (sum of lines e and f)						\$4,887,832.25	
h. Unobligated balance of Federal funds (line d minus g)						\$273,662.75	
<b>Recipient Share:</b>							
i. Total recipient share required						\$5,161,495.00	
j. Recipient share of expenditures						\$5,161,495.00	
k. Remaining recipient share to be provided (line i minus j)						\$0.00	
<b>Program Income:</b>							
l. Total Federal program income earned							
m. Program income expended in accordance with the deduction alternative							
n. Program income expended in accordance with the addition alternative							
o. Unexpended program income (line l minus line m or line n)							
11. Indirect Expense	a. Type	b. Rate	c. Period From	Period To	d. Base	e. Amount Charged	f. Federal Share
	Predetermined	50.00%	9/1/2009	8/31/2014	1,388,977.06	694,488.53	694,488.53
g. Totals:					1,388,977.06	694,488.53	694,488.53
12. Remarks: total funds were not expended, a budget reduction of \$273,662.75 will be processed							
13. Certification: By signing this report, I certify that it is true, complete, and accurate to the best of my knowledge. I am aware that any false, fictitious, or fraudulent information may subject me to criminal, civil, or administrative penalties. (U.S. Code, Title 18, Section 1001)							
a. Typed or Printed Name and Title of Authorized Certifying Official <b>Diane Wechsler, Accountant</b>					c. Telephone (Area code, number and extension) 301-405-6662		
b. Signature of Authorized Certifying Official <i>Diane Wechsler</i>					d. Email address <a href="mailto:dwechsle@umd.edu">dwechsle@umd.edu</a>		
					e. Date Report Submitted (Month, Day, Year) 11/20/2014		
					14. Agency use only:		
Standard Form 425 OMB Approval Number: 0348-0061 Expiration Date: 10/31/2011							
<b>Paperwork Burden Statement</b> According to the Paperwork Reduction Act, as amended, no persons are required to respond to a collection of information unless it displays a valid OMB Control Number. The valid OMB control number for this information collection is 0348-0061. Public reporting burden for this collection of information is estimated to average 1.5 hours per response, including time for reviewing instructions, searching existing data sources, gathering and maintaining the data needed, and completing and reviewing the collection of information. Send comments regarding the burden estimate or any other aspect of this collection of information, including suggestions for reducing this burden, to the Office of Management and Budget, Paperwork Reduction Project (0348-0060), Washington, DC 20503.							

## Appendix B. Project Research and Development Objectives, by Working Group and Year

ID	PROJECT OBJECTIVES AND GOALS	WORKING GROUP	PROJECT ACTIVITIES BY QUARTER																			
			YEAR 1				YEAR 2				YEAR 3				YEAR 4				YEAR 5			
			9-2009	12-2009	3-2010	06-2010	9-2010	12-2010	3-2011	06-2011	9-2011	12-2011	3-2012	06-2012	9-2012	12-2012	3-2013	06-2013	9-2013	12-2013	3-2014	06-2014
University of Maryland Greenhouse Research																						
1.6.1	On-campus research		Begin plant physiological studies (water use) and varyify sensor calibrations. Begin Model development.				Integrate sensor physiological research to next iteration of node networks. Continue physiological greenhouse studies and validate Model design				Finalize Model development and receive input from industry				Resolve any industry issues and concerns with Model use							
1.6.2	On-farm research		Deploy present generation node networks at commercial farm with commercial greenhouse partners. Begin initial monitoring.				Deploy next iteration of node networks at commercial greenhouse. Begin to validate Model. Test monitoring and irrigation control capabilities				Contiue research with node networks with commercial greenhouse partners. Resolve issues with Model and irrigation control capabilities				Finalize Model and monitoring and irrigation control issues for commercialization.							
1.6.3	Technology implementation		Continue monitoring and begin irrigation control. Apply research data for Model development. Employ GUI.				Refine GUI and Model. Continue monitoring and control research and develop baselines. Determine spatial and temporal probe requirements.				Beta testing model/GUI software.				Release of commercial product							
1.6.4	Outreach		Preliminary findings presented at local extension programs and national conferences.				Write peer reviewed and trade journal manuscripts.				Previous seasons findings presented at local extension programs and national conferences.				Write peer reviewed and trade journal manuscripts.				National conferences and extension programming.			
1.6.5	Synergistic activities		Share monitoring and control data with CMU,UG, Cornell, UC and Decagon to develop model crop software and GUI.																			
1.6.6	Software and Modeling		Begin initial modeling research and develop baselines for Model GUI software development.				Begin model validation. Varyify GUI utility.				Comntinue model validation and GUI utility.				Beta testing model/GUI software.				Release of commercial product.			
In-Ground/Out of Ground Nursery Research																						
1.6.1	Field station research		Deploy present generation node networks at Field Research Station. Varyify probe calibrations. Begin initial monitoring and irrigation control.				Deploy next iteration of node networks at Field Station. Conitnue testing monitoring and irrigation control capabilities.				Continue node network research at Field Station. Continue testing monitoring and irrigation control capabilities. Determine spatial and temporal variations for Model.				Finalize node network research at Field Station. Wrap up monitoring and irigation control.				Finalize Model development and receive input from industry. Resolve any industry issues and concerns with Model use.			
1.6.2	Commerical farm Research		Deploy present generation node networks at Commercial Farm. Begin initial monitoring.				Conitnue research on node networks at Commercial Farm. Begin monitoring and initial irrigation control. Employ GUI.				Deploy present generation node networks at Field Research Station. Begin initial monitoring and irrigation control.				Deploy present generation node networks at Field Research Station. Begin initial monitoring and irrigation control. Employ GUI.				Finalize Model development and receive input from industry. Resolve any industry issues and concerns with Model use.			
1.6.3	Technology implementation		Employ GUI at Reaserch Farm				Validate GUI effectiveness and improve				Determine GUI usefulness and improve				Determine GUI usefulness and improve based on industry needs				Release of commercial product			
1.6.4	Outreach		Preliminary findings presented at local extension programs and national conferences.				Write peer reviewed and trade journal manuscripts.				Previous seasons findings presented at local extension programs and national conferences.				Write peer reviewed and trade journal manuscripts.				National conferences and extension programming			
1.6.5	Synergistic activities		Share monitoring and control data with CMU,UG, Cornell, UC and Decagon to develop model crop software and GUI.																			
	Software and Modeling		Begin initial modeling research (Buaerie) and develop baselines for model/ GUI software development.				Varyify GUI utility.				Begin model validation and GUI utility.				Beta testing model/GUI software.				Release of commercial product			

ID	PROJECT OBJECTIVES AND GOALS	WORKING GROUP	PROJECT ACTIVITIES BY QUARTER																							
			YEAR 1				YEAR 2				YEAR 3				YEAR 4				YEAR 5							
			9-2009	12-2009	3-2010	06-2010	9-2010	12-2010	3-2011	06-2011	9-2011	12-2011	3-2012	06-2012	9-2012	12-2012	3-2013	06-2013	9-2013	12-2013	3-2014	06-2014				
	<b>Green Roof Systems Research</b>																									
1.6.1	On-campus/Field station research		Begin probe calibrations to green roof media and use node system in macroscale research				Resolve issues with calibrations to green roof media																			
1.6.2	On-location research						Deploy node network on greenroof system				Conintue research on node network on greenroof system				Conintue research on node network on greenroof system											
1.6.3	Technology implementation						Employ GUI and begin water budget modeling.				Continue water budget modeling. Validate GUI.				Continue water budget modeling. Validate GUI.											
1.6.4	Outreach		Preliminary findings presented at local extension programs and national conferences.				Write peer reviewed and trade journal manuscripts.				Previous seasons findings presented at local extension programs and national conferences.				Write peer reviewed and trade journal manuscripts.				National conferences and extension programming.							
1.6.5	Synergistic activities		Share monitoring and control data with CMU,UG, Cornell, UC and Decagon to develop model crop software and GUI.																							
1.6.6	Software and Modeling						Begin initial modeling research and develop baselines for Model GUI software development.				Verify GUI utility.				Begin model validation and GUI utility.				Beta testing model/GUI software.				Release of commercial product.			

ID	PROJECT OBJECTIVES AND GOALS	WORKING GROUP	PROJECT ACTIVITIES BY QUARTER																			
			YEAR 1				YEAR 2				YEAR 3				YEAR 4				YEAR 5			
			9-2009	12-2009	3-2010	06-2010	9-2010	12-2010	3-2011	06-2011	9-2011	12-2011	3-2012	06-2012	9-2012	12-2012	3-2013	06-2013	9-2013	12-2013	3-2014	06-2014
	<b>Carnegie Mellon University</b>																					
Hardware Development																						
Design	Decagon, CMU		team tech review	new node design		iterate design			iterate design			iterate design										
Manufacture	Decagon				engineering prototype	build 50 field prototypes				build preproduction prototypes											produce/market sensor network system	
Evaluate	Decagon, CMU				test/evaluate prototypes				collect engineering data from test sites				ollect engineering data from preproduction test sites								collect engineering data on production units	
Deployments	Decagon, CMU		existing system to Bauers, UMD Greenhouse, Wye (others?)				field prototypes to test sites				preproduction prototypes to test sites				production units to test sites							
GUI Development																						
Development	CMU, Decagon, Antir		team tech review	rough GUI	dababase	design GUI, refine database	final GUI design/development, develop supporting documentation			refine GUI												
Evaluate	CMU, Decagon, Antir					evaluate database and GUI	collect user feedback, evaluate			collect user feedback, evaluate											collect user feedback, evaluate	
Deployments	CMU, Decagon		rough GUI to existing field sites				GUI prototype to field sites (alpha test)				GUI beta test				market GUI as part of sensor network system							
Crop-Specific Plug-Ins																						
Petunia	CMU, Georgia, Antir		implement				evaluate at U. Georgia				beta test				market							
Red Maple	CMU, CSU, Antir						implement				evaluate at CSU				beta test				market			
Green Roof	CMU, UMD, Antir														implement				evaluate at green roof test site			
Snapdragon	Antir, UMD, CMU										implement				evaluate at Bauers Greenhouse				beta test			

ID	PROJECT OBJECTIVES AND GOALS	WORKING GROUP	PROJECT ACTIVITIES BY QUARTER																			
			YEAR 1				YEAR 2				YEAR 3				YEAR 4				YEAR 5			
			9-2009	12-2009	3-2010	06-2010	9-2010	12-2010	3-2011	06-2011	9-2011	12-2011	3-2012	06-2012	9-2012	12-2012	3-2013	06-2013	9-2013	12-2013	3-2014	06-2014
	University of Georgia																					
	Greenhouse/nursery research																					
1.6.1	On-campus research		Determine effects of substrate water content on physiology, growth, and quality of different greenhouse crops, quantify water needs, start model development				Determine whether soil moisture sensor-controlled irrigation can be used to control stem elongation and improve plant quality, effects of substrate water content on physiology, growth, and quality of different nursery crops, continue model development				Validate petunia water use model, incorporate model into software, determine how optimal fertilization practices should be altered with soil moisture sensor-controlled irrigation, continue work on stem elongation and plant quality.				Wrap up greenhouse research, address issues raised by industry partners, continue nursery research on plant morphology and quality				Wrap up nursery research, address unresolved issues raised by industry partners			
1.6.2	On-farm research		Quantify water use and plant water needs				Implement soil moisture sensor based irrigation, quantify water savings, effects on plant quality				Implement altered fertilization practices, quantify reductions in fertilizer use and nutrient leaching											
1.6.3	Technology implementation		Maintain and provide support for wireless network at EverGreen (already in place) and install wireless network at McCorkle				Upgrade on-farm wireless networks to incorporate control capability								Upgrade wirelees networks with latest GUI							
1.6.4	Outreach		Present preliminary findings at trade shows, present data at scientifi meeting				Publish first manuscript, write trade magazine articles				Publish manuscripts, write trade magazine articles				Publish manuscripts; Organize field day at industry partners for county faculty and growers; Develop outreach materials Web-based, PowerPoints, extension publications, trade magazine articles				Publish manuscripts; Organize field day at industry partners for county faculty and growers; Develop outreach materials Web-based, PowerPoints, extension publications, trade magazine articles			
1.6.5	Synergistic activities		Share water use and environmental data with UM, CSU, and Cornell; collaborate with UM on model development; Collect data needed for social and economic analyses				Share water use and environmental data with UM, CSU, and Cornell; collaborate with UM on model development; Collect data needed for social and economic analyses				Collaborate with UM/Antir on incirporating water use model into software; Collect data needed for social and economic analyses				Collect data needed for social and economic analyses							

ID	PROJECT OBJECTIVES AND GOALS	WORKING GROUP	PROJECT ACTIVITIES BY QUARTER																			
			YEAR 1				YEAR 2				YEAR 3				YEAR 4				YEAR 5			
			9-2009	12-2009	3-2010	06-2010	9-2010	12-2010	3-2011	06-2011	9-2011	12-2011	3-2012	06-2012	9-2012	12-2012	3-2013	06-2013	9-2013	12-2013	3-2014	06-2014
	Colorado State University																					
	Nursery research																					
1.6.1	On-campus research		Deploy CMU node network with sensors at ARDEC, continue model parameterization and validation (from prior research), deploy lidar, and determine species specific water use and needs				Determine initial optimization of a macro-scale distributed environmental sensing network, scale species estimates from whole trees to stand and compare to measured values, continue model development				Detailed spatial analysis and validation of nursery water use model, deploy lidar, begin incorporation of model into software, schedule irrigation treatments for prescribed irrigation evaluation				Wrap up ARDEC site research but yet address any unresolved issues				Address any unresolved issues			
1.6.2	On-farm research		Deploy CMU node network with sensors at Willoway, quantify water use and plant water needs, deploy lidar, quantify physiological variables and calculate model parameters				Determine initial optimization of macro-scale distributed environmental sensing network, deploy lidar, scale species estimates from whole trees to nursery beds and sections and compare to different nursery crop measured values, continue model development				Deploy lidar, determine spatial node and sensor placement and derive optimal system component placement and quantity per unit area, continue physiological measures, model development and scaling validation.				Wrap up Willoway site research but address any unresolved issues and demonstrate system to national audience							
1.6.3	Technology implementation		Install wireless network at ARDEC and Willoway				Upgrade on-farm wireless networks to incorporate control capability				Incorporate latest GUI				Continue upgrade wireless networks with latest GUI							
1.6.4	Outreach		Present preliminary findings to Willoway employees, present data at scientific meeting				Submit first manuscript, write trade magazine articles				Present initial findings to national industry audience at Willoway site, publish manuscripts, write trade magazine articles				Publish manuscripts, hold field day at ARDEC, Develop outreach materials - Web-based, PowerPoints, extension publications, trade magazine articles				Hold national association short course to present to industry at Willoway site and Publish manuscripts			
1.6.5	Synergistic activities		Share water use and environmental data with UM, UG, and Cornell; collaborate with UM on model development; Collect data needed for social and economic analyses				Share water use and environmental data with UM, UG, and Cornell; collaborate with UM, UG, and Cornell on model development; Collect data needed for social and economic analyses				Collaborate with UM/Antir on incorporating water use model into software; Collect data needed for social and economic analyses				Collect data needed for social and economic analyses							